

Service-Handbuch
Service Booklet

Scrubmaster B 175 R
(7180.XX)

Schulung/Training
Fehlersuche/Troubleshooting
Einstelldaten/Adjustments



Table of contents

1	Information	7
2	General information	8
	2.1 Settings	11
	2.1.1 Control panel	12
	2.1.2 Machine control unit	13
	2.2 Brief description	14
	2.2.1 Switching off suction / waste water tank full	15
	2.2.2 Solution tank display	16
	2.2.3 Machine home position	18
	2.2.4 Seat contact switch (3.6.6.4.)	19
	2.3 Diagnostics and communications	21
	2.3.1 Prerequisites	21
	2.3.2 Diagnostic software on the diagnostic computer	22
	2.3.3 Connecting to the diagnostic PC	23
	2.3.4 Connection scheme with the diagnostic PC	25
	2.3.5 Flashing the software	26
	2.3.6 Flashing the SD Card	27

Table of contents

2.4	Configuration menu	29
2.4.1	Entering the configuration menu	29
2.4.2	Time and Date setting menu	32
2.4.3	Configuration setting menu	33
2.4.4	Settings, that can be carried out without code	35
2.4.5	Settings, that can only be carried out with code	36
2.4.6	Resetting the last error and deleting the error memory	37
2.4.7	Deleting the last error on the display panel	38
2.4.8	Deleting error entries	39
3	Technical data	40
4	Maintenance intervals	48
4.1	Hako system maintenance (customer)	49
4.2	Hako system maintenance I	51
4.3	Hako system maintenance II	54
4.4	Hako system maintenance S	55
5	Cleaning programmes (FPV)	56
5.1	Cleaning programmes (SOW)	59

Table of contents

6	Machine settings	61
	6.1 Basic settings	61
	6.1.1 Cleaning units	62
	6.1.2 Battery and charger settings	65
	6.1.3 Battery setting (LDS)	66
	6.1.4 Charger	68
	6.1.5 Charger characteristic curves	70
	6.1.6 Charging data table of the integrated charger	71
	6.1.7 All-wheel drive variant – X-AC	72
	6.1.8 SD storage medium in control panel	73
	6.1.9 Logo on the starting screen	74
	6.2 Customer-specific settings (PPV)	75
7	Mechanical components	78
	7.1 Squeegee	78
	7.2 Rotating brush heads	84
	7.3 Roller brush heads	85
	7.4 Lifting element brush head	86
	7.4.1 Potentiometer in the lifting element for the brush head	86

Table of contents

8	Water pump	87
	8.1 Water supply – components on the water plate	88
	8.2 Water quantities	89
	8.3 Water pump standstill detection	90
	8.4 Suction-and speay tool; Spray nozzle	91
9	Drive system	92
	9.1 DMC drive control unit (front)	93
	9.1.1 Connection description - drive control unit (front)	93
	9.1.2 Service codes - drive control unit (front)	95
	9.1.3 Brake - manual release of the brake (front)	101
	9.1.4 Brake – testing the brake function	102
	9.2 DMC drive control unit (rear)	103
	9.2.1 Connection description - drive control unit (rear)	103
	9.2.2 Service codes - drive control unit (rear)	105
	9.2.3 Brake at the rear axle	110
	9.2.4 Steering angle sensor	111

Table of contents

10	Service messages	115
	10.1 Meaning of different switch on displays	120
	10.2 Service alarm clock 3.3.1.1	121
11	Battery charger	122
	11.1 Operating manual	122
	11.2 Programming the charger	126
12	Options	127
13	Electrical Components	132
	13.1 Machine control unit A01	132
	13.2 Dashboard A02	136
14	Notes	138

1. Information

Caution:

- During all work at the machine, secure it against unintentional movement.
- Only carry out work at the machine when it has been de-energised (disconnect the battery plug), except for current and voltage measurements.
- After repairing electrical drives, measure the starting and operating currents to detect possibly still present errors.
- During all work at the machine, always observe the general safety and accident prevention regulations of the legislation.

2. General information

The Scrubmaster B175 R is equipped with a multifunction display on which all machine statuses are displayed and machine settings can be made.

If a fault occurs, the wrench in the display lights up and the machine beeps. The current **service code** (four-digit alphanumeric code in the service indicator) is shown **with flashing dots between the characters**.

In addition, a red open-ended spanner  can be displayed above the icon of the affected unit.

The corresponding service code is then determined via the "Service information" menu, if not shown in the operating hours display.

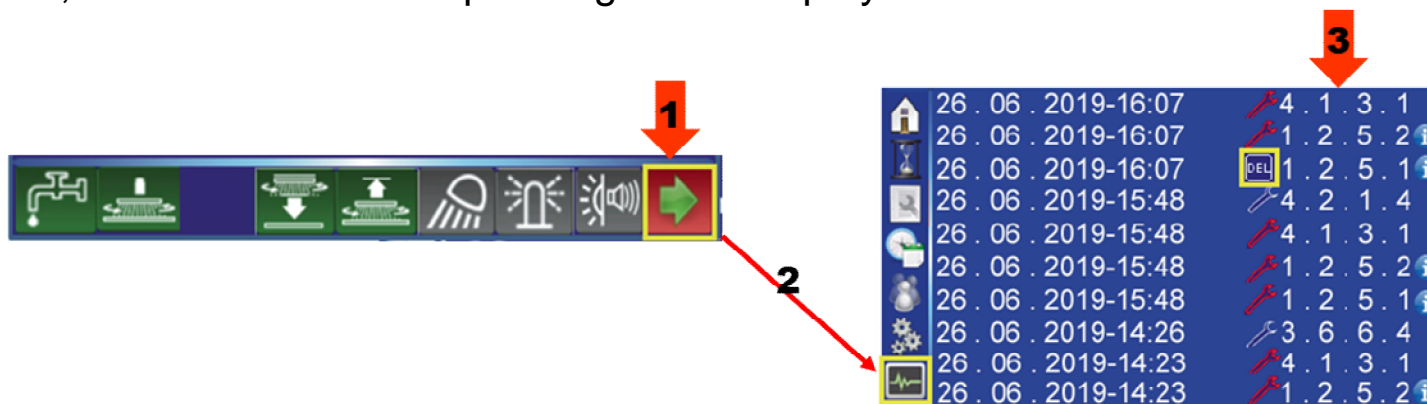

2. General information

Scrubmaster B175 R

The Scrubmaster B175 R is available in working widths of between 85 cm (cylindrical brush) as well as 90 cm and 108 cm (plate brush).

The machines are delivered from the factory with batteries as standard; here it is possible to choose between a maintenance-free 36V/280Ah PzV trough battery and a 36V/320Ah PzS trough battery.

Furthermore, it is differentiated between edition machines and configuration machines. Edition machines are machines that have a clearly defined scope of equipment. In this context, only a limited scope of additional equipment features is available. Additional options are not installed in the factory but supplied loose with the delivery for installation on site at the customer's.

A separate operating manual, which describes the operating and service statuses of the charger, is available for the chargers and supplied together with the device. The charge indicator is shown on the machine display. Service messages of the charger are also shown on the machine display.

2. General information

Configuration machines are manufactured order-specifically according to customer wishes from a pool of available equipment features. Additional options (chemical dosing, working light, warning signal, etc.) are installed in the factory. For more details, see the relevant current price lists.

Matrix for a ready-for-use machine

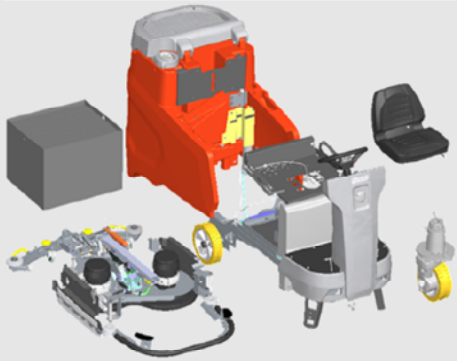
<div data-bbox="285 686 542 782" data-label="Text"> <p>Configurable basic unit</p> </div> 	+ required equipment	
	<div data-bbox="678 743 919 786" data-label="Text"> <p>Working tools</p> </div> 	<div data-bbox="1213 725 1522 806" data-label="Text"> <p>Solution/recovery tank</p> </div> 
	<div data-bbox="678 868 774 903" data-label="Text"> <p>Drive</p> </div> 	<div data-bbox="1213 868 1344 903" data-label="Text"> <p>Battery</p> </div> 
	<div data-bbox="678 989 823 1032" data-label="Text"> <p>Charger</p> </div> 	<div data-bbox="1213 989 1435 1025" data-label="Text"> <p>Power cable</p> </div> 
	<div data-bbox="678 1110 871 1146" data-label="Text"> <p>Driver seat</p> </div> 	<div data-bbox="1213 1110 1315 1146" data-label="Text"> <p>Tyres</p> </div> 
	<div data-bbox="678 1232 929 1268" data-label="Text"> <p>Cleaning tools</p> </div> 	<div data-bbox="1213 1232 1460 1268" data-label="Text"> <p>User manuals</p> </div> 

2.1 Settings

Respective settings can be carried out via the machine's configuration menu. Currently, these settings are carried out via the machine display. There are settings which can also be carried out by the operator without restrictions (e.g. cleaning programmes in Chapter 3 and several settings in Chapter 2). This is always possible if a diskette is displayed next to the value (Chapter-Configuration-Content). However, if a lock is displayed a diagnostic connector with order number PN 03006790 is required to adjust this value, or a 4-digit PIN must be entered in the field above it. This is described in more detail in the Configuration chapter.

2.1 Settings

2.1.1 Control panel - MFD

In order for the display of the control panel to work, a micro-SD card must be inserted on the PCB of the control panel containing a special image file. This is required to make the control panel work. A micro-SD card with the required image file can be written to using the Hako diagnostics. See chapter 2.3.6.

If the micro SD card is missing, the display shows only a “Blue Screen” with time and working hours (figure 2.1). If the image file on the card is defective or missing, the control panel will show a “black screen” with or without a message (figure 2.3).

If the display is showing the loading screen, the dashboard is activated, but there is no communication with the machine control unit (figure 2.2).

The micro SD card cannot be read by the usual computer operating systems (Windows, Linux, IOS, Android).



Figure 2.1



Figure 2.2

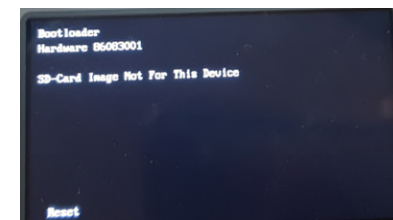

Figure 2.3

2.1 Settings

2.1.2 Machine control unit

A new machine control unit is supplied without machine software ex spare parts warehouse. Following mechanical and electrical installation of the central control unit in a machine and switching on the key switch, the display will be in an indeterminate state, since no data has been transferred from the machine control unit to the control panel. (“Loading screen”; service code 4.5.2.5. ; 4.5.3.5.).

Therefore, the machine software must be “flashed” onto the central control unit after mechanical installation and electrical connection of the central control unit. In connection with each regular service of the machine, check whether new machine software and / or control panel software is available. If so, install the latest software on the machine. If necessary, also update the control panel software on the SD card.

- Service PC on which the current Hako diagnostic software is installed.
(Windows 10 or higher)
- 1 free USB 2.0 port
- CAN-FOX interface PN 03502430
- Alternatively, CANUSB interface PN 03501750
- Interface cable PN 03502750

2.2 Brief description

Machine control takes place with the following electronics:

- Central electronics (A01) – CAN-Module
- Control and display panel (A02) (MFD) – CAN-Module
- Drive control unit (A04) / All-wheel-drive-option — 2. Drive control unit (A05) – CAN-Module
- Chemical dosing (A101)
- Side brush control (A07) – for machines of the first production period

The control electronics (A01) assumes all control and monitoring tasks in the machine except for the drive functions.

As well as the group messages of the drive control unit on the display of the machine, these are displayed as detailed flash codes on the drive control using flashing LEDs (see Chapter 9) and as additional information behind the “info”-icon in the service information list .

It is possible to toggle back and forth between the tip switches for scrubbing, suction and the green Hakomatic button for combined cleaning, thus ensuring that the selected function is activated. When pressing tip switch “boost”, the brush pressure is increased and the water quantity set to max. as long as the tip switch is pressed.

Tool operation can only be switched on if the parking brake is applied and the seat contact switch is open.

2.2 Brief description

2.2.1 Switching off suction / waste water tank full

Suction is switched off by the operator via the tip switch or automatically in case of the signal “waste water tank full” to protect the suction turbine.

Switching off by the operator:

- The squeegee is raised.
- The suction motor switches off with a delay (15 seconds).

Switching off because the tank is full:

The suction motors are shut off when the waste water tank is full via float switch S04, which is connected to the machine control unit A01:X15.4 and A01:X15.16.

A full recovery tank is indicated in the display by the symbol



2.2 Brief description

2.2.2 Solution tank display

The machine has a fill level indicator for the solution water tank in the MFD which displays the current fill level in steps of 20%. 

If the filling level has left approx 10l, the display is signalling this with this icon: 

The fill level is measured via a differential pressure sensor. The pressure sensor is connected to an immersion tube via a hose which is located next to the water filling opening of the fresh water tank. The immersion tube extends to just above the bottom of the fresh water tank. A certain pressure is present at the pressure sensor via the immersion tube and the hoses, which is converted into an electrical signal by the electronics of the pressure sensor. This signal is evaluated by the machine control unit and shown on the display as a fill level signal.

2.2 Brief description

2.2.2 Solution tank display

(calibration of filling level indication)

The sensor is supplied with a voltage of 5V via A01:X14.5. The minus connection comes from A01:X15.15, and the analogue signal of the pressure sensor is present at A01:X15.3.

If there is a water column in the immersion tube, this can result in falsification of the actual fill level on the display. The display is calibrated by completely draining the fresh water tank once. The immersion tube in the fresh water tank is completely emptied when this takes place.

In this state, switch on the machine, so that the pressure sensor recognises the reference pressure "tank empty".

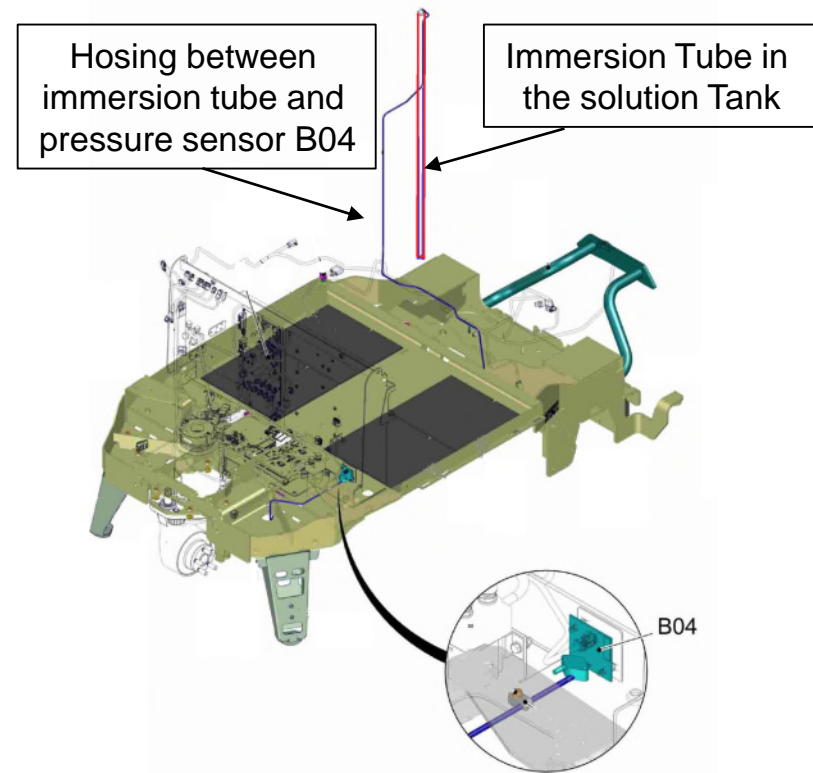

2.2 Brief description

2.2.3 Machine home position

After switching on the machine, all components are set to “home position” provided that the seat contact switch is actuated (closed).

The lifting elements will lift unless they have been switched off via the micro-switch for the upper end position integrated in the lifting element (squeegee) or the upper end position is detected by the control unit via the integrated potentiometer.

When removed, the spindle of the lifting element may not be twisted as otherwise the positioning of the lifting element is misaligned.

2.2 Brief description

2.2.4 Seat contact switch (3.6.6.4.)

The seat contact switch (S05) is connected to the control electronics A1 at A1:X15.6+18 and A1:X15.7+19.

The control electronics (A1) responds to the relief of the seat with an approx. 2 second delay. This means: If the contact at A1:X15.6+18 is open for more than 2 seconds during machine operation, the motors stop.

If the switch is closed again within 2 seconds, the machine continues to operate without any interruptions.

If the seat contact switch is not actuated for > 6 hours while the key switch is switched on, the machine is locked in all functions (driving and cleaning). The same applies if both contacts of the seat contact switch have the same switch status for longer than a few seconds, i.e. both switches are detected as being open or closed by the machine (seat switch manipulation).

The service code 3.6.6.4. is shown in the operating hours meter. If the seat contact switch is actuated, only driving is now possible. If the key switch is switched off and then back on without the seat contact switch being relieved or actuated again, the driving function is also deactivated. The machine is blocked for use if the seat contact switch is not actuated.

2.2 Brief description

To reactivate the machine after triggering “seat switch manipulation”, the machine control unit must “register” the change of the switch status or the change between ‘operator is sitting on the machine’ and ‘operator has left the seat’.

To achieve this, the seat contact switch must be opened and closed several times while the machine is on.

A seat contact switch that has been detected as “open” by the machine (no operator on the seat) is indicated on the control panel display via the “operator” in the top line of the MFD. If the seat contact switch is detected as “closed”, i.e. the operator is on the seat, the operator symbol in the MFD will go off.

Seat contact switch closed means there is an operator on the seat; Seat contact switch **open** means there is **no** operator on the seat.

The second seat contact switch always has the respective opposite switching status.

2.3 Diagnostics and communication

2.3.1 Prerequisites

The following components are required to activate the control unit of the Scrubmaster B175 R after a replacement:

- Current Hako diagnostic software (via the Hako WebX download portal)
- Service PC (e.g. Panasonic CF20 / FZ55)
- Interface PN 03502430 * (preferred variant) or alternatively also: PN 03501750 **
- Diagnostic cable PN 03502750
- Diagnostic connector PN 03006790

See Chapter 2.3.4 for connections to the recommended interface

2.3 Diagnostics and communication

2.3.2 Diagnostic software on the diagnostic computer

Download the “HakoDiagnostics” software as a zip file or as a folder from the Hako WebX download area.

Information on accessing the download server can be requested from Christin Ramm, e-mail: cramm@hako.com.

To install the software on a service computer or for software updates:

Follow the steps in the “Instructions” for Hako diagnostics setup which is supplied with the diagnostic software.

The diagnostic software is then updated automatically during the current year via the Hako update tool.

2.3 Diagnostics and communication

2.3.3 Connection to the diagnostic PC

- Ensure that the –A01 control unit has been fully installed in the machine before activating the backup battery. To do this, remove the insulating strip between the battery (CR2032) and the battery holder on the control unit.
- Connect the interface (* / **) to a free USB port of the service PC.
- Establish a connection between the machine and the diagnostic computer using the diagnostic cable (PN 03502750) and the interface (PN 03502430 or 03501750).
- Connect the OBD connector (blue contact protection) of the diagnostic cable to the OBD contact of the machine (located behind the cover in the steering column).



In case the machine is connected to the diagnosis computer via the serial communication cable at connector –A01.X20, the option Fleetrecorder is activated automatically. This will inhibit the machine, as long as no fleetrecorder is installed in the machine. In this case, the "Fleet recorder" option must then be deactivated (Chapter 12 - Options).

2.3 Diagnostics and communication

With CAN-FOX interface PN 03502430 (*): (recommended variant – see Chapter 2.1.3)

Connect the D-Sub 9 connection of the diagnostic cable marked CAN1 (red marking) to the D-Sub 9 connection of the interface marked “CAN”.

Caution: Do not use the D-Sub 9 connection with the designation RS232.

With CANUSB interface PN 03501750 (**): (*alternative connecting option*)

Connect the D-Sub 9 connection of the diagnostic cable marked CAN1 (red marking) to the round jack of the interface using the adapter (D-Sub 9 to 7-pin round plug) included in the scope of delivery of the diagnostic cable.

- Carry out the settings for operative units, options, battery and parameters via the display according to the training documents.

2.3 Diagnostics and communication

2.3.4 Diagram for connection between machine and the diagnostic PC

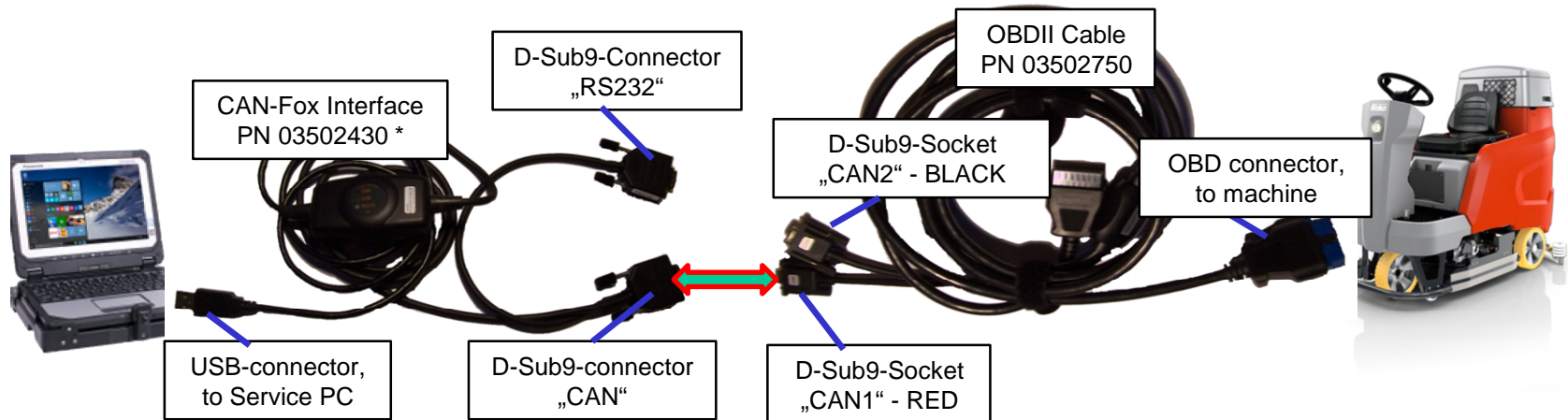

2.3 Diagnostics and communication

2.3.5 Flashing the software:

- Turn on the machine.
- Start the Hako diagnostic software. Select the “HAKO” button, then click the “Scrubmaster B175 R” button. The application independently searches for a new, blank control unit.
- Follow the instructions of the programme. Do not turn off the machine or disconnect the connection before flashing has been completed.
- Carry out the settings for operative units, options, battery and parameters via the display according to the training documents.

2.3 Diagnostics and communication

2.3.6 Flashing the SD-Card :

For installation of a new dash board software, remove the Micro-SD-Card from the SD-Slot of the dash board. Insert the micro SD-card in a empty SD-slot of your diagnosis computer (may a Micro-SD=>SD Adaptor is required). Alternative a USB-Micro-SD-Adaptor can be used.

- Switch on the machine (without a connected machine the diagnostic application can´t be started).
- Start the Hako-Diagnostic-Software. Select the „HAKO“-button, then press the Button „** B260R.
- Then select the tab „System“

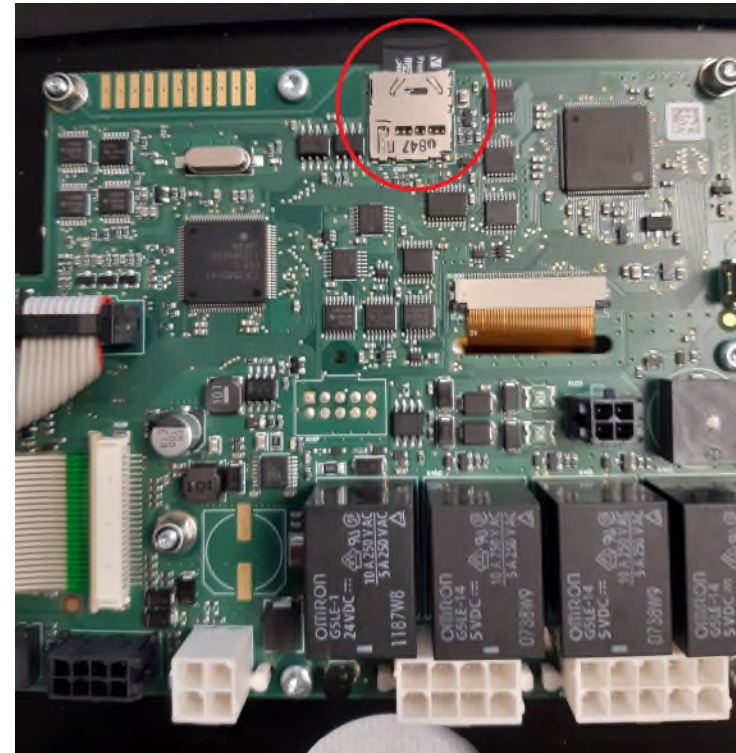

This picture indicates the position of the SD-card in the dash board.

2.3 Diagnostics and communication

2.3.5 Flashing the SD-Card :

- Select the button „write micro-SD card“, this will start the flashing process
- Now follow the instructions on the screen
- Switch off the machine and insert the SD-card in the SD-slot of the dash board.
- Switch on the machine
- A message „Bootloader“ and two software version numbers will appear on the screen, if a new software version is available
- Two buttons appear in the bottom line: „ Cancel“ and „Update“
- The button „Update“ is selected by pressing the „Turn-push-knob“. All other activities will escape the software update.
- Now the initialising of the new dashboard software starts.
- Wait till the screen displays the „Loading“ Screen.
- Switching off and on again the machine, will complete the software update of the dash board.

2.4 Configuration Menu

2.4.1 Entering the configuration Menu

The turn-push knob can be used to access sub-menus in which it is possible to

- set machine configurations
- set the clock
- delete the last error in the display and the error overview

Select the sub-menus:

In the main display screen, use the turn-push knob to select the red button with the green arrow and actuate it by pressing the turn-push knob. The display screen jumps into the sub-menu on the operating hours meter page.

Use the turn-push knob to select the desired menu item and actuate it by pressing the turn-push knob.

- Time/Date setting
- Configuration menu
- Error memory for resetting the last error

2.4 Configuration Menu

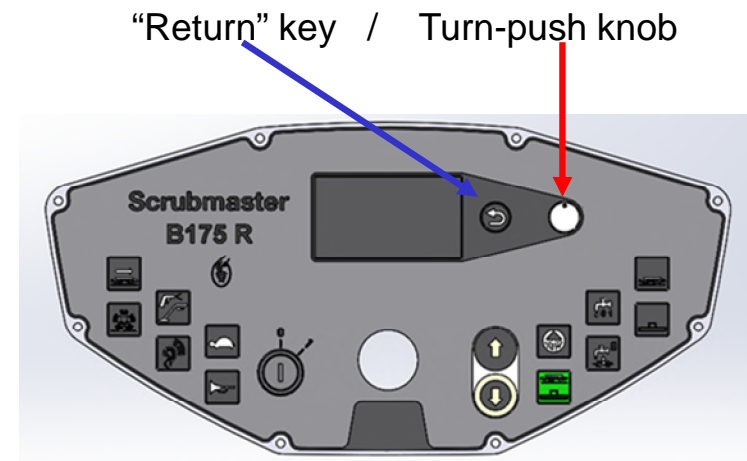
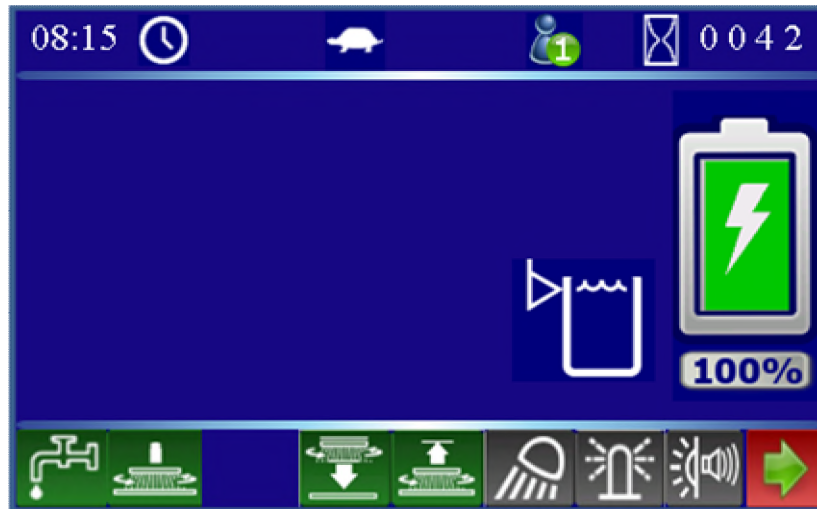

“Menu selection” softkey for selecting the sub-menus.

The sub-menu of the operating hours appears and the select buttons are displayed on the left-hand side (with yellow border for selection).

2.4 Configuration Menu

Go back to the main menu using

- the return key on the keypad
- or
- the home button (softkey) on the display panel

“Menu selection” softkey for selecting the sub-menus.
The sub-menu of the operating hours appears and the select buttons are displayed on the left-hand side (with yellow border for selection).
The individual menus can be selected using the turn-push knob.

Time setting menu

Configuration setting menu

Service messages menu

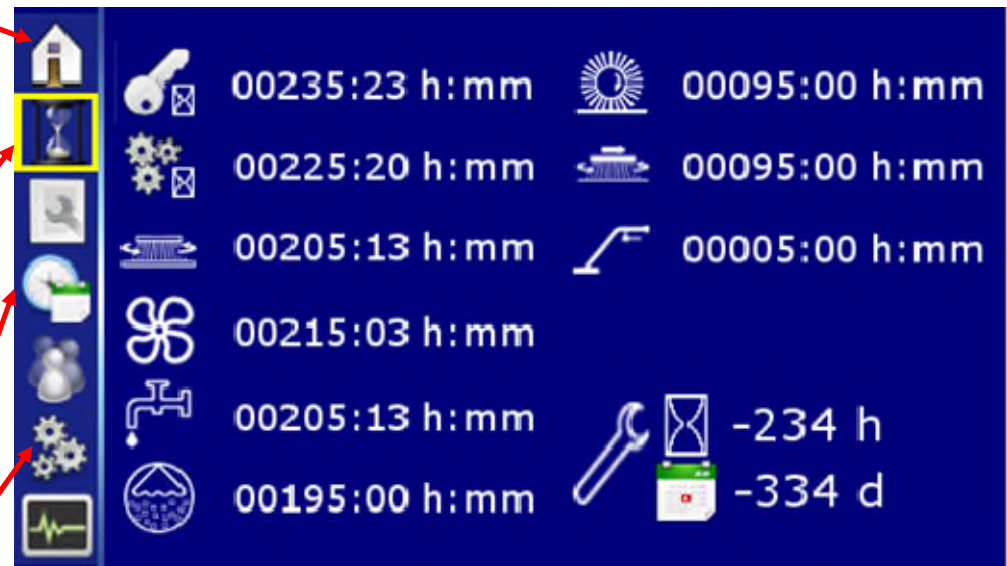

2.4 Configuration Menu

2.4.2 Time and date setting menu

- Respective times and dates can be set in the time/date setting sub-menu.
- Time selection 12 h / 24 h in hours/minutes,
- Date in day/month/year
- Turn the turn-push knob to the adjustable parameters and press. If the border turns green, the parameter can be adjusted. Press again to save. Turn further to the next value to be adjusted.
- Values are saved automatically when exiting the menu item (turning the turn-push knob on the time setting menu item).

Menu item for setting the time. Select the softkey via the turn-push knob and press to confirm.

Date setting section

Time setting section

12 h / 24 h setting

Hour setting

Minute setting

Setting: Day Month Year

Use the return key on the keypad to exit the menu. The set values are accepted.

Taste "Rücksprung" / Dreh-Druck-Steller

ubmaster B175 R

The diagram illustrates the configuration menu interface. On the left, a vertical sidebar contains icons for home, clock, search, settings, and a turn-push knob. The main menu is divided into two sections: 'Time setting section' and 'Date setting section'. The time setting section displays a clock icon, a selection between '12h' (highlighted in green) and '24h', and the time '10:12 am'. The '12h' option is labeled '12 h / 24 h setting'. The hour '10' is labeled 'Hour setting' and 'hh', and the minute '12' is labeled 'Minute setting' and 'mm'. The date setting section displays a calendar icon and the date '15.03.2017'. The day '15' is labeled 'Day' and 'DD', the month '03' is labeled 'Month' and 'MM', and the year '2017' is labeled 'Year' and 'YYYY'. Below the date fields, the text 'Setting: Day Month Year' is shown. To the right, a physical keypad is shown with a return key labeled 'Taste "Rücksprung" / Dreh-Druck-Steller' and a turn-push knob. The keypad is labeled 'ubmaster B175 R'. A text box above the keypad states: 'Use the return key on the keypad to exit the menu. The set values are accepted.'

2.4 Configuration Menu

2.4.3 Configuration setting menu

- Respective options and values can be adjusted in the system settings sub-menu “configuration menu”.
- Adjustable values are divided into operator settings (can be changed by the operator), service settings (can only be changed by service staff using a password, diagnostics plug PN 03006790 or diagnostics device), and non-adjustable values (can only be changed via a software update).
- Turn the turn-push knob to the adjustable parameter and press. If the border turns green, the content can be adjusted. Save the value via the “disk” icon.

Menu item for setting the configurations. Select the softkey via the turn-push knob and press to confirm.

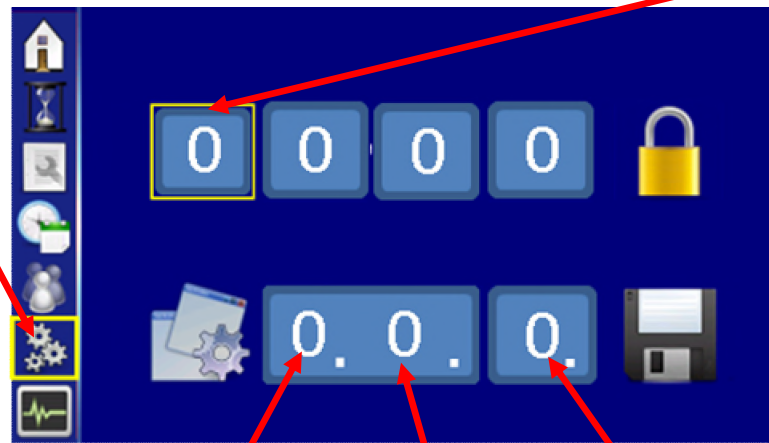

Chapter

Configuration

Content

Enter the code here.

The code is calculated using the last 4 digits of the 12-digit serial number of the machine plus 1.

These are the positions 9 to 12 of the serial number of the machine.

2.4 Configuration Menu

Use the return key on the keypad to go back without saving the currently selected value.

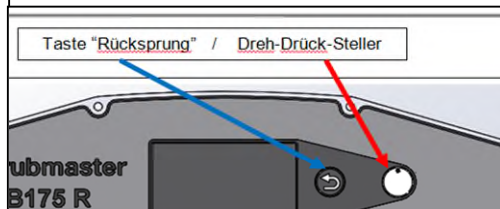

Menu operation:

- Turn the turn-push knob to access the field of the value to be changed.
- Press the turn-push knob to be able to adjust the value (the border turns green).
- Adjust by turning the turn-push knob.
- Press the turn-push knob to exit the field. Turn further to the disk to save the value.

- Connect the diagnostics plug PN 03006790 to –A01/X20 to change the protected parameters.

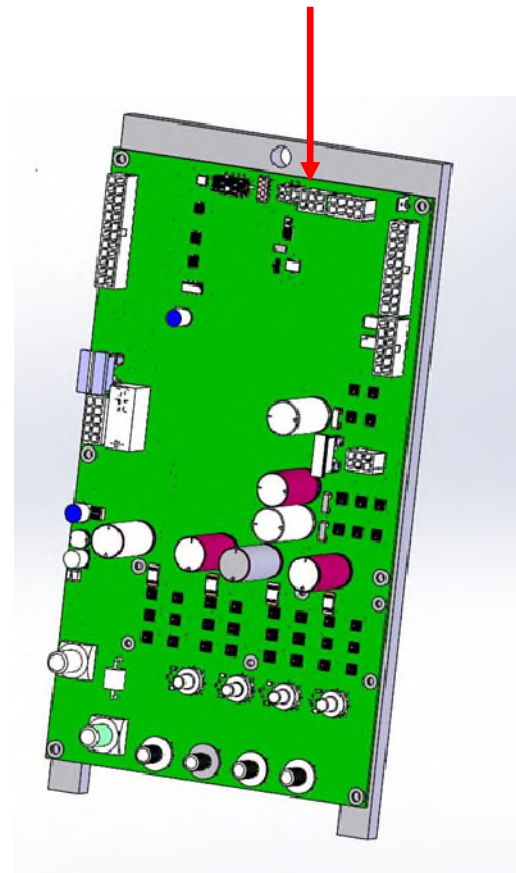

2.4 Configuration Menu

2.4.4 Settings that can be carried out without code or diagnostics plug

Settings that can be carried out by the operator are indicated by not having to enter a code in the top field (or connecting a diagnostics plug) and by the disk displayed next to the configuration setting for saving. Without a code, all settings can be viewed but only released ones can be adjusted.

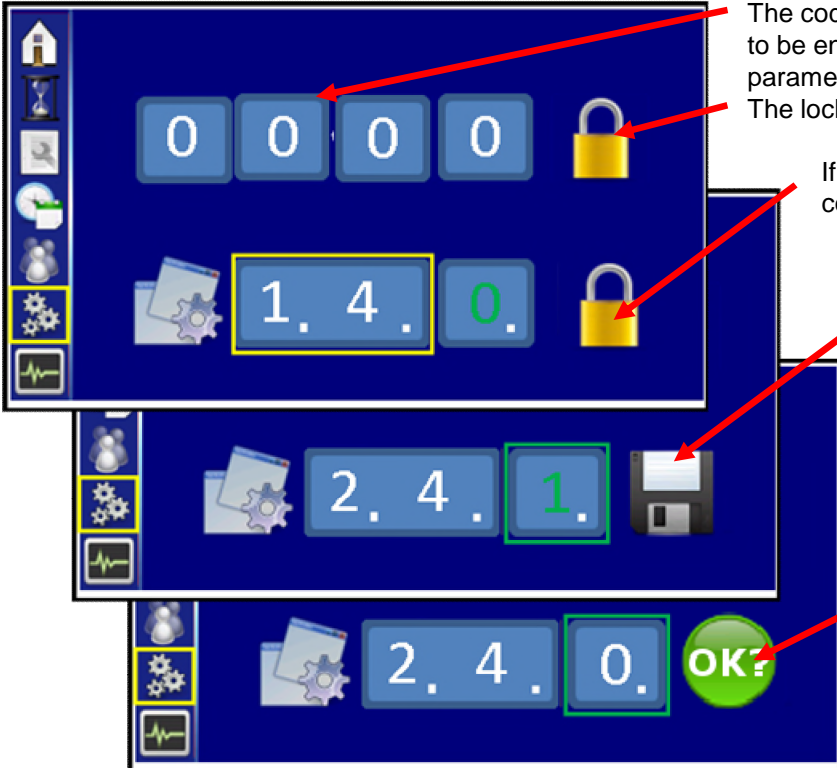

The diagram illustrates the Hako configuration menu in three states:

- Top Panel:** Shows a code field with four '0's and a yellow padlock icon. A red arrow points to the code field with the text: "The code or diagnostics plug for setting parameters does not have to be entered or connected if the operator wants to adjust parameters (only released parameters can be adjusted). The lock is locked." Another red arrow points to the padlock icon with the text: "If a locked lock is shown next to the configuration setting, the configuration cannot be changed by the operator."
- Middle Panel:** Shows a configuration setting with a gear icon, a field containing "1.4.", and a yellow padlock icon. A yellow border highlights the "1.4." field. A red arrow points to the padlock icon with the text: "If a disk is shown next to the configuration setting, the configuration can be changed by the operator. A green number means: currently saved content. A green border means: the value can be adjusted."
- Bottom Panel:** Shows the same configuration setting with a gear icon, a field containing "2.4.", and a disk icon. The "2.4." field has a green border. A red arrow points to the disk icon with the text: "The content can be adjusted by turning the turn-push knob. The number turns white and 'OK?' appears as a prompt to save this value." Another red arrow points to the "OK?" button with the text: "After saving, the disk appears and the number turns green. If saving should not take place, use the 'return' key on the keypad or the turn-push knob to exit the setting."

2.4 Configuration Menu

2.4.5 Settings that can only be carried out with code or diagnostics plug

Settings that can be carried out by service staff are indicated by having to enter a code in the top field and by the disk displayed next to the configuration setting for saving.

To avoid having to enter a code, it is also possible to use the diagnostics plug PN 03006790 at connection – A01.X20 of the control unit.

The code is assigned by the HAKO Service during production at the assembly line or when installing a new control unit. The code is calculated from the running sequence number of the machine plus 1.

The running sequence numbers are the positions 9 to 12 of the serial number of the machine.

If no code has been assigned, release for adjusting the configuration can only take place via the service plug.

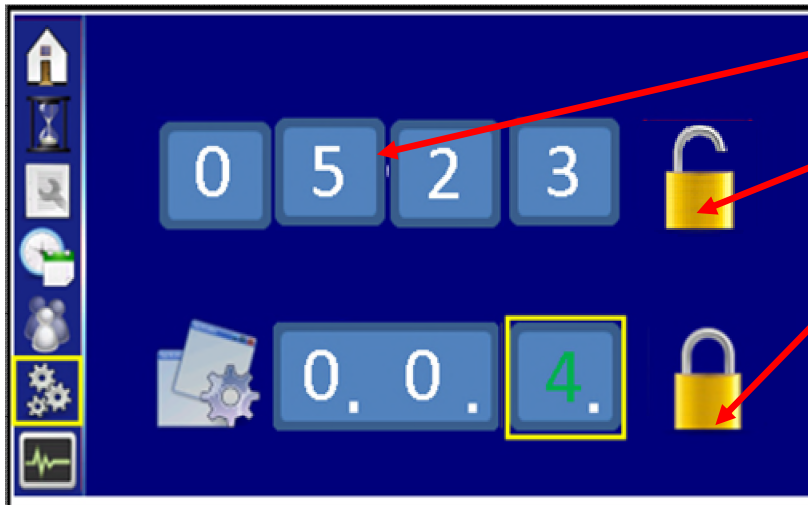

If parameters are to be changed, the code for setting parameters must be entered (alternatively, diagnostics plug).

The lock is unlocked.

If a locked lock is shown next to the configuration setting, the configuration cannot be changed by service staff.



If a disk is shown next to the configuration setting, the configuration can be changed by service staff. A green number means: the currently saved content.



The content can be adjusted by turning the turn-push knob, the number then turns white and “OK?” appears as a prompt for saving the value. After saving, the disk appears and the number turns green. If saving should not take place, use the “return” key on the keypad to exit the setting.

2.4 Configuration Menu



2.4.6 Resetting the last error and deleting the error memory

- The last ten errors can be displayed with real time and date in the error information sub-menu.
- The last error can be deleted in the main display.
- The display of the last ten errors can be deleted. However, the diagnostics memory cannot be deleted.

Shows the time when the error occurred in:
 24 h display – hh:mm:ss or
 12 h display – pm/am hh:mm:ss

Shows the date when the error occurred in: DD.MM.YYYY

Shows the status of the error (several errors can be active / inactive):

- Service key RED:  Active/Inactive error
- DEL:  The error is displayed for 3 seconds after switching on the machine.

Menu item for displaying the last ten errors. Select the softkey via the turn-push knob and press to confirm.



	13:06:00 - 31.03.2016		2.5.5.2	
	13:06:00 - 31.03.2016		1.2.4.0	
	13:06:00 - 31.03.2016		1.2.4.0	
	13:06:00 - 31.03.2016		2.5.5.2	
	13:05:00 - 31.03.2016		1.2.3.5	
	13:04:00 - 31.03.2016		1.2.3.6	
	13:03:00 - 31.03.2016		2.5.5.2	
	13:02:00 - 31.03.2016		1.2.3.8	
	13:00:00 - 31.03.2016		2.5.5.2	
	13:01:00 - 31.03.2016		1.2.3.9	

Error display sequence: The last occurred error is displayed at the top, previous errors are displayed underneath.















Service code

Call detailed information

2.4 Configuration Menu

2.4.7 Deleting the last error on the display panel

- Use the cursor to navigate to “DEL” between time / date and the error message of the last occurred error (“DEL” is only visible if the error has been reset, i.e. the service key has extinguished).
- Press and hold the turn-push knob for 3 seconds to reset the error indicators for the main display screen.
- “DEL” disappears from the display.

	13:06:00 - 31.03.2016	DEL	2.5.5.2	
	13:06:00 - 31.03.2016		1.2.4.0	
	13:06:00 - 31.03.2016		1.2.4.0	
	13:06:00 - 31.03.2016		2.5.5.2	
	13:05:00 - 31.03.2016		1.2.3.5	
	13:04:00 - 31.03.2016		1.2.3.6	
	13:03:00 - 31.03.2016		2.5.5.2	
	13:02:00 - 31.03.2016		1.2.3.8	
	13:00:00 - 31.03.2016		2.5.5.2	
	13:01:00 - 31.03.2016		1.2.3.9	

2.4 Configuration Menu

2.4.8 Deleting error entries

- The entries in the display (not the diagnostics memory) can only be deleted via the HAKO diagnostics system.
- New error entries are saved chronologically (the last occurred error is displayed at the top position).

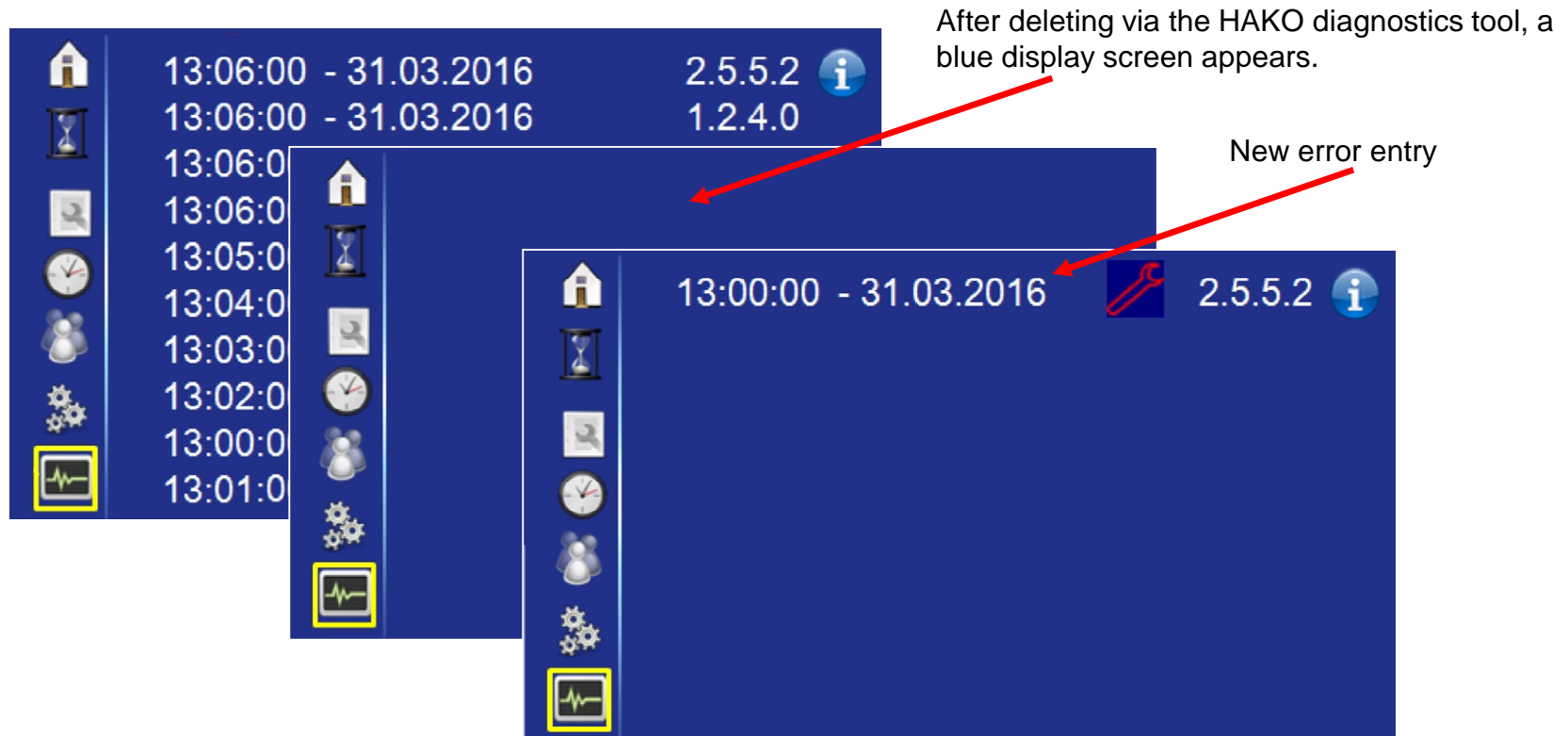

3 Technical Data

Dimensions

		Standard drive			X-AC drive
Name	Unit	TB 900	TB 1080	WB 850	TB 900
Length of machine with squeegee without/with pre-sweep unit	mm	1890/2670	1890/2670	1890	1890/2670
Width of machine without/with squeegee	mm	940/1130	1120/1290	940/1130	940/1130
Height of machine without/with overhead guard	mm	1450/2080			

Working width

Brush unit	mm	900	1080	850	900
Squeegee	mm	1100	1260	1100	1100

Weights

Weight (empty, without batteries)	kg	450	455	440	480
Total weight (ready for use)	kg	1010	1015	1100	1040
Permissible total weight	kg	1310			

3 Technical Data

Driving performance

		Standard drive			X-AC drive
Name	Unit	TB 900	TB 1080	WB 850	TB 900
Driving speed transportation (forwards/reverse)	km/h	8/4			
Climbing capacity when cleaning	%	6 (2 min)			15 (up to 5 min/ 4 km/h)
Climbing capacity during transport journey (ready for operation)	%	10 (1 min)			18 (3 min/ 4 km/h)
Ramp angle/Slope angle	%	16			
Turning circle (with squeegee)	mm	2960	2970	2960	2960

3 Technical Data

Wheels

		Standard drive			X-AC drive
Name	Unit	TB 900	TB 1080	WB 850	TB 900
Wheel diameter	mm	305			
Specific wheel contact pressure front/rear	N/mm ²	0.66/0.65			

Tank contents

Solution tank	Litre	175
Waste water tank	Litre	175

Brush head

Brush speed	rpm	210	210	850	210
Min./Max. brush pressure	kg	35/70	38/70	29/38	35/70

Vacuum system

Air quantity 1/2 suction turbine	m ³ /h	100/200	200	100/200	100/200
Vacuum (maximum)	mbar	approx. 50			

3 Technical Data

Electrical system

		Standard drive			X-AC drive
Name	Unit	TB 900	TB 1080	WB 850	TB 900
Nominal voltage	V	36			
Nominal output (max.) (P1)	W	7470			
Power consumption drive motor (P1) S2-120 min	W	2335			3365
Power consumption of vacuum motor (P1) 1/2 suction turbine	W	641/ 1282	1282	641/1282	641/ 1282
Power consumption of brush motor (P1) with/without side brush	W	2x936	2x936	2x918 + 2x115	2x936
Power consumption water pump (P1)	W	approx. 67			
Type of protection		IPX 3			
Protection class		III			

3 Technical Data

On-board charger

		Standard drive			X-AC drive
Name	Unit	TB 900	TB 1080	WB 850	TB 900
Rated input/output voltage	V	230/36			
Nominal output	W	1600			
Type of protection		IPX 3/P20			
Protection class		I			

3 Technical Data

Pre-sweep suction unit

Name	Unit	
Machine length	mm	800
Height of machine	mm	660
Machine width (above swivel bracket)	mm	1220
Working width	mm	1300
Cylindrical brush width	mm	670
Cylindrical brush, minimum diameter	mm	200
Cylindrical brush speed	rpm	500
Sweeping level width	mm	45±10
Side brush diameter	mm	400
Side brush speed	rpm	92
Theoretical sweeping capacity	m ² /h	10400
Dirt hopper volume (maximum load 20 kg)	Litres	16
Filter area	m ²	1.4
Filter use category ZH 1/487	KAT	U
Drive motor (P1)	W	756
Nominal voltage	V	36
Permissible total weight	kg	115

3 Technical Data

Noise emission value

		B175 R WZB		B175 R TB	
		Standard operation	Silent operation	Standard operation	Silent operation
The sound power level (L_{wAd}) measured under the customary conditions of use according to DIN EN 60335-2-72 is:	dB (A)	85	80	85	80
The sound pressure level (L_{pA}) (at the ear of the driver) measured under the customary conditions of use according to DIN EN 60335-2-72 is:	dB (A)	68	64	68	64
Measuring uncertainty (K_{pA})	dB (A)	1.4	1.5	1.6	1.3

3 Technical Data

Vibration

Under the customary conditions of use, the weighted effective value of the acceleration to which the upper limbs (hand-arm) are subjected to according to DIN EN ISO 5349 is:	m/s ²	≤ 2.5
Under the customary conditions of use, the weighted effective value of the acceleration to which the body (feet or seat surface) is subjected to DIN EN ISO 2631-1 is:	m/s ²	≤ 0,5

4. Maintenance

The Hako system maintenance specifies in single modules the special technical work to be done and the periods of time for the maintenance activities. Parts to be replaced for the individual maintenance tasks are determined.

Hako system maintenance:

- Assures the reliable readiness for use of the Hako cleaning machines (preventive maintenance).
- Minimises operating costs, repair costs, costs for maintenance.
- Assures long life and readiness for use of the machine.

4.1 Hako-System Maintenance (customer)

Hako system maintenance customer:

Work to be performed by the customer by reference to the servicing and maintenance instructions specified in the operating manual.

Daily
• Emptying the waste water tank
• Clean the waste water tank, drain hose, coarse dirt sieve and suction filter
• Check the cover seal of the waste water tank, clean if necessary
• Check the battery, charge if necessary
• Check the squeegee, clean if necessary
• Emptying the dirt hopper in the roller brush unit (optional)

4.1 Hako-System Maintenance (customer)

Weekly
• Clean the machine as required
• Clean the solution tank
• Check the sieve insert in the fresh water filter, clean or replace if necessary
• Check the scrubbing performance of the brushes/pads, clean if necessary
• Check the brushes and water retaining ring for proper fit and wear, replace if necessary
• Check the suction performance of the squeegee, clean or replace the sealing strips if necessary
• Check the fresh water supply to the brushes, clean if necessary
• Check the suction hose for tight fit and damage, clean if necessary
• Check the rubber of the lateral wiper, replace if necessary
• Pre-sweep unit (optional), check rotating cylindrical brush, clean if necessary
• Trial run and function test

4.2 Hako-System Maintenance I

Hako system maintenance I:

Performance by an expert of an authorised Hako workshop by reference to the machine-specific system maintenance.

Every 250 hours
<ul style="list-style-type: none"> • Check the battery and the charger • Check the battery acid level and acid density, refill demineralised water if necessary • Check the air inlet grilles, air duct and filter mat of the on-board charger for contamination, clean or replace if necessary
<ul style="list-style-type: none"> • Check steering for stiffness and play • Check steering pinion and gear rim for damage, grease if necessary.
<ul style="list-style-type: none"> • Check the brake for proper functioning
<ul style="list-style-type: none"> • Check the cover seal of the waste water tank, replace if necessary • Check operation of float switch in waste water tank. • Check the waste water and suction system, replace worn parts if necessary
<ul style="list-style-type: none"> • Check the fresh water supply, replace worn parts if necessary
<ul style="list-style-type: none"> • Check the sealing strip/slot strip of the squeegee, turn or replace if necessary • Check the deflecting bracket/deflecting rollers at the squeegee, replace if necessary • Check the squeegee setting, reset if necessary

4.2 Hako-System Maintenance I

Every 250 hours
<ul style="list-style-type: none"> • Check the sieve insert and cover seal of the fresh water filter for damage, replace if necessary
<ul style="list-style-type: none"> • Check the seal at the drain hose, replace if necessary
<ul style="list-style-type: none"> • Check the condition of tyres • Check the rear wheel mounting screws, re-tighten if necessary (42 Nm)
<ul style="list-style-type: none"> • Check the electrical system (lighting, fuses and relays), replace parts if necessary
<ul style="list-style-type: none"> • Remove fluff and dirt from the air inlet grilles of the brush motors
<ul style="list-style-type: none"> • Check toothed belt and bearing of the roller brush unit, replace if necessary
<ul style="list-style-type: none"> • Check V-belt drive of pre-sweep unit (optional) • Check the rotary brush setting, reset if necessary
<ul style="list-style-type: none"> • Check the side brush setting (optional), reset if necessary
<ul style="list-style-type: none"> • Check the front collision protection with deflecting roller for damage

4.2 Hako-System Maintenance I

Every 250 hours
Spray the following locations on the machine with penetrating lubricant:
<ul style="list-style-type: none">• Hinges at the squeegee lift system• Hinges at the side deflectors• Hinge and joint locations of the brush lift system
<ul style="list-style-type: none">• Check the optical condition of the machine (corrosion and labels)
<ul style="list-style-type: none">• Trial run and function test

4.3 Hako-System Maintenance II

Hako system maintenance II:

Performance by an expert of an authorised Hako workshop by reference to the machine-specific system maintenance.

Every 500 hours
<ul style="list-style-type: none">• All maintenance work according to Hako system maintenance I
<ul style="list-style-type: none">• Read out the error memory and evaluate the service information
Check the following electrical output: <ul style="list-style-type: none">• Drive motor• Brush motors• Suction turbines• Pre-sweep unit (optional)• Side brush unit (optional)
<ul style="list-style-type: none">• Trial run and function test

4.4 Hako-System Maintenance III/S (Safety Check)

Hako system maintenance III/S (safety check)

Performance by an expert of an authorised Hako workshop by reference to the machine-specific system maintenance. Performance of all legally stipulated safety-relevant tests according to the BGV specifications.

Every 1000 hours
<ul style="list-style-type: none">• All maintenance work according to Hako system maintenance II
<ul style="list-style-type: none">• Replace the backup battery of the electrical control and set a real-time clock
<ul style="list-style-type: none">• Remove coal dust from the brush motors, the side brush unit motor and the pre-sweep unit motor and check the carbon brushes for ease of movement and wear, replace carbon brushes if necessary
<ul style="list-style-type: none">• Trial run and function test

5. Cleaning Programs (FPV)

The cleaning programmes are used to control the behaviour of the water supply to the brushes, the brush motors with regard to the position of the driving direction switch and the speed control potentiometer (forwards, neutral, reverse) as well as the squeegee.

A GND signal is connected to input A04:A3 of the drive control unit via the speed control potentiometer switch in B03. This is the release signal for the drive control unit. When driving direction forwards is selected on the control panel, this signal is connected to input A04:A1 from A02:X109.3. When reversing is selected, the signal is connected to input A04:A2 from A02:X109.4. If these signals are missing at A04:A1 or A04:A2, the machine cannot be driven.

The “forwards” and “reverse” signals are transferred to the machine control unit via CAN-bus and the cleaning units are therefore activated. The behaviour of the cleaning functions is described in Table 5.1.

In order to select a cleaning programme, you must switch to the programming level as described in Chapter 2.4 Configuration (sub-chapters 2.4.3 and 2.4.4). The available cleaning programmes are listed in Table 5.2.

5. Cleaning Programs (FPV)

		Content						
Function	Content	0	1	2	3	4	5	6
Brush off when drive control is in neutral	SOW	Yes	Yes	Yes	Yes	Yes	Yes	Yes
Brush off when drive control is in reverse	SOW	No	No	Yes	No	No	Yes	Yes
Lift brush when drive control is in neutral	SOW	No	No	No	Yes	Yes	Yes	Yes
Lift brush when drive control is in reverse	SOW	No	No	No	No	No	No	Yes
Water off when drive control is in neutral	SOW	Yes	Yes	Yes	Yes	Yes	Yes	Yes
Water off when drive control is in reverse	SOW	No	Yes	Yes	No	Yes	Yes	Yes
Lift squeegee when drive control is in neutral	SOW	No	No	No	No	No	No	No
Lift squeegee when drive control is in reverse	SOW	Yes	Yes	Yes	Yes	Yes	Yes	Yes
Speed reduction when brush on	SOW	No	No	No	No	No	No	No
Speed reduction when suction on	SOW	No	No	No	No	No	No	No
Speed reduction when brush and suction on	SOW	No	No	No	No	No	No	No
Broom off,when drive control is in neutral	SOW	No	No	No	No	No	No	No

Table 5.1

5. Cleaning Programs (FPV)

Chapter	Configuration	Content	Description	B175R
3	0		Adjusted FPV	
3	0	0	SOW Variante (see Configuration 3.1...3.d)	x
3	0	1	Refer to FPV table	x
3	0	2	Refer to FPV table	d
3	0	3	Refer to FPV table	x
3	0	4	Refer to FPV table	x
3	0	5	Refer to FPV table	x
3	0	6	Refer to FPV table	x

Table 5.2

5.1 Cleaning Programs (SOW)

The following settings can only be made if the cleaning programme has previously been set to 3.0.0.

Chapter	Configuration	Content	Description	B175R
3	1		SOW: Brush off, when drive pedal neutral	
3	1	0	No	x
3	1	1	Yes	x
3	2		SOW: Brush off, when drive pedal revers	
3	2	0	No	x
3	2	1	Yes	x
3	3		SOW: Lift Brush, when drive pedal neutral	
3	3	0	No	x
3	3	1	Yes	x
3	4		SOW: Lift Brush, when drive pedal revers	
3	4	0	No	x
3	4	1	Yes	x
3	5		SOW: Water off, when drive pedal neutral (only information)	
3	5	1	Yes	x
3	6		SOW: Water off, when drive pedal revers	
3	6	0	No	x
3	6	1	Yes	x

Table 5.3 a

5.1 Cleaning Programs (SOW)

Chapter	Configuration	Content	Description	B175R
3	7		SOW: Lift Squeegee, when drive pedal neutral	
3	7	0	No	x
3	7	1	Yes	x
3	8		SOW: Lift Squeegee, when drive pedal revers	
3	8	0	nein	x
3	8	1	ja	x
3	9		SOW: Reduce speed, when brushes on	
3	9	0	No	x
3	9	1	Yes	x
3	A		SOW: Reduce speed, when suction on	
3	A	0	No	x
3	A	1	Yes	d
3	B		SOW: Reduce speed, when brushes and suction on	
3	B	0	No	x
3	B	1	Yes	d
3	D		SOW: pre sweep off, when drive pedal neutral	
3	D	0	No	x
3	D	1	Yes	d

Table 5.3 b

6. Machine settings

6.1 Basic settings

The machine series Scrubmaster B175 R offers different equipment options and working widths. These can be set and adapted in the configuration menu. To check and change the setting, access the configuration menu as described in Chapter 2.4. The possible setting parameters are described in the following chapters.

6. Machine settings

6.1 Basic settings

6.1.1 Cleaning units

3 different brush units are used with the Scrubmaster B175 R.

Two plate brush units with a working width of 90 cm or 108 cm, and a cylindrical brush unit with a working width of 85 cm.

This setting is necessary for correct functioning of the overrange limits and water quantities.

To check and change the setting of the cleaning units, proceed as described in Chapter 2.4 Configuration. The possible setting parameters for the operative units are specified in Table 6.1.

For Machine control units on from Hardware version 11 (PN 01385160), a DIP switch (SW800) is present, which adapts the control unit to the brush deck type (plate brush or cylindrical brush). This switch setting must correspond to the brush deck setting in parameter 0.2.x.

In case of a mismatch between the hardware adjustment of SW800 and the software adjustment in 0.2.x, a service message is generated (1.2.6.b.).

6. Machine settings

6.1 Basic settings

6.1.1 Cleaning units

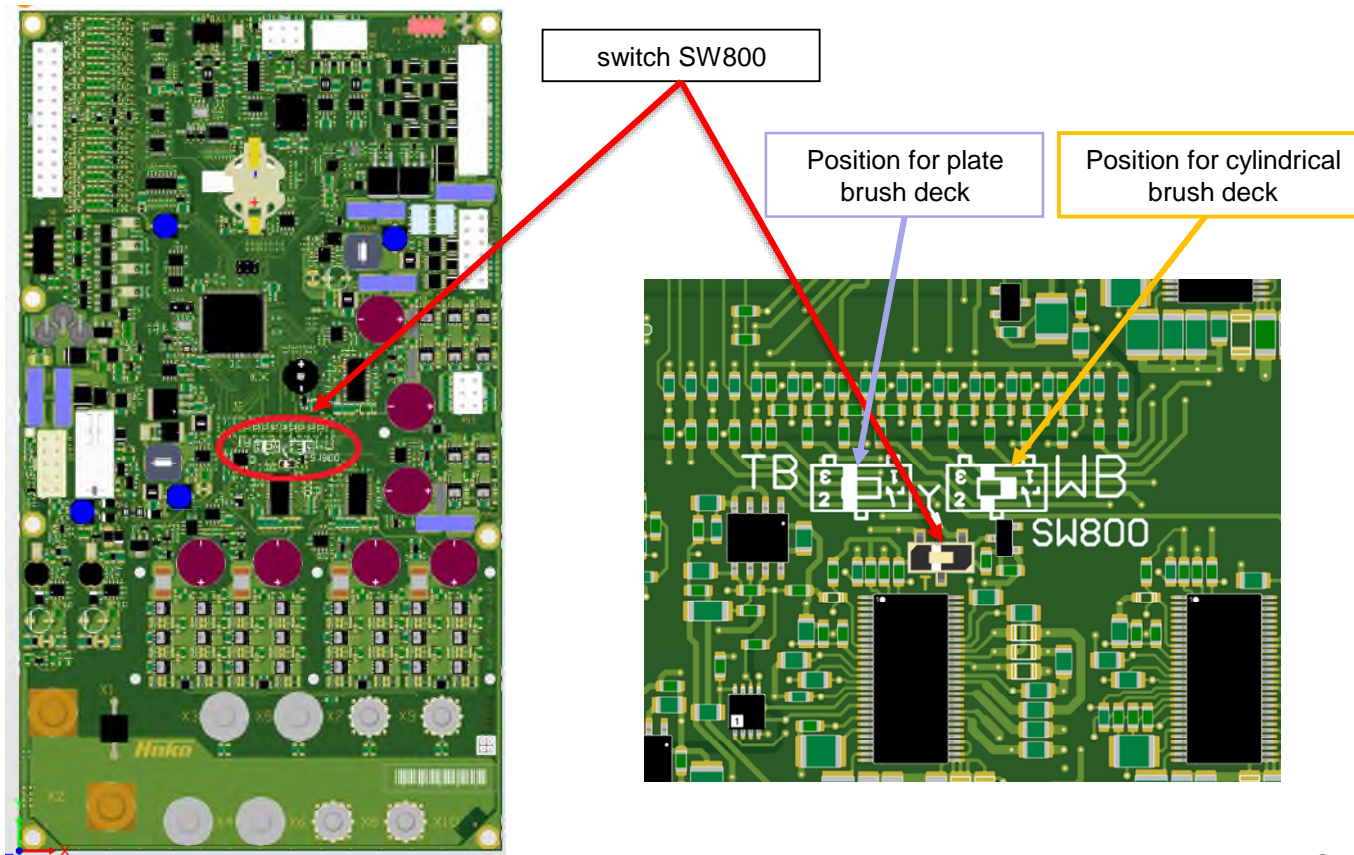

6. Machine settings

6.1.1 Cleaning units

Chapter	Configuration	Content	Description	B175R
0	2		Brush decks	1
0	2	4	Plate brush deck 900mm	x
0	2	7	Cylindrical brush deck 850mm	x
0	2	A	Plate brush deck 1080mm	x

Table 6.1

6. Machine settings

6.1.2 Battery and charger settings

In order to achieve optimum service life and performance of the batteries available for the machine, it is necessary to set the battery monitor, called LDS, and the charger to the correct battery type and capacity.

These settings are carried out in the menu items 0.3.X; 0.4.X and 0.5.X.

If the setting for a machine without charger (0.4.0), with charger and without communication (0.4.1) or for a charger with communication and free characteristic curve selection (0.4.2) is carried out in 0.4.x, the LDS must also be set correctly in 0.3.X.

With the charger settings 0.4.6 and 0.4.7, the LDS setting takes place automatically via the battery selection in 0.5.X.

Chapter 0.3.X is then not shown in the configuration menu.

6. Machine settings

6.1.3 Battery settings (LDS)

PzS and PzV are batteries with tubular type plates.



GiV and Pzv are encapsulated, completely maintenance-free gel batteries.

PzS are sealed, low-maintenance batteries containing liquid electrolyte. Regular checking of the electrolyte as well as topping up with distilled water are required here.

AGM batteries have glass mat separators.

The following designations are also used for monobloc batteries:

GiV = GF-Y; GF-V

PzS = FT

Trough batteries are available in the following versions:

EPzS / EPzB and EPzV

6. Machine settings

6.1.3 Battery settings (LDS)

Chapter	Configuration	Content	Description	B175R
0	3		LDS Adjustment - Battery-Type (only for 0.4.0; 0.4.1 and 0.4.2)	1
0	3	0	Crown w/o Offset	x
0	3	1	Crown	x
0	3	2	GIS, „Foreign“	x
0	3	3	GiS	x
0	3	4	PzS or PzB „Foreign“	x
0	3	5	PzS or PzB	x
0	3	6	GiV	x
0	3	7	PzV	x
0	3	8	AGM - only for Hoppecke batteries	x

Table 6.2

6. Machine settings

6.1.4 Battery Charger

In this menu item (0.4.X), it is specified whether the machine features an integrated charger and whether this charger communicates with the machine control unit via CAN bus.

With chargers that communicate with the machine, there are various selection options. If the charger with a free characteristic curve selection is selected, the correct characteristic curve must be determined using the charger documents and then set correctly under 0.5.X. The column under 0.4.2 in Table 6.4 then applies to this setting. When selecting the chargers PzV (0.4.6) PzS (0.4.7), only the characteristic curves that can be operated with these chargers are shown under 0.5.X (see table 6.4 in columns 0.4.6 and 0.4.7)

Check and change the setting as described in Chapter 2.4 Configuration. The possible setting parameters are specified in Table 6.4.

6. Machine settings

6.1.4 Battery Charger

Chapter	Configuration	Content	Description	B175R
0	4		Battery charger and Battery types	1
0	4	0	w/o battery charger	x
0	4	1	battery charger w/o communication	x
0	4	2	Battery charger with communication (manual charging characteristics selection)	x
0	4	6	Battery charger with communication for PzV-batteries	x
0	4	7	Battery charger with communication for PzS/PzB-batteries	x

Table 6.3

6. Machine settings

6.1.5 Charging Characteristics

Chapter	Configuration	Content	Description			B175R
0	5		Charging characteristic / Battery size			1
			for 0.4.2	for 0.4.6	for 0.4.7	
0	5	0	LK0	--	--	x
0	5	1	LK1	--	--	x
0	5	2	LK2	--	--	x
0	5	3	LK3	--	320Ah PzS	x
0	5	4	LK4	--	--	x
0	5	5	LK5	280Ah PzV	--	x
0	5	6	LK6	--	--	x
0	5	7	LK7	--	--	x
			Automatic LDS setting			x

Table 6.4

6. Machine settings

6.1.6 Charging characteristics for integrated charger

 Industrie
 ELEKTRONIK
 Brilon GmbH

 Kennlinientabelle – Hako
 Batterieladegerät 36V 35A

Filon Futur M

Typ: E 230 G 36/35 B45-FPO

Programm	0	1 Werkseinstellung	2	3	4	5	6	7	8
Batteriespannung	36V	36V	36V	36V	36V	36V	36V	36V	36V
HAKO-Batterie	240Ah PzS	315Ah PzS 320Ah PzS	420Ah PzS	180Ah GiV	240Ah GiV	280Ah PzV	198Ah AGM Discover	Yellow Top 5,5 75Ah Optima	240Ah Crown
Batterietyp	PzS / PzB	PzS	PzS	GiV	GiV	PzV	AGM	AGM	Gel
Kapazität allgemein	240-300Ah	315-393Ah	420-525Ah	180-270Ah	240-360Ah	240-291Ah	230Ah	75Ah	240Ah
Kennlinie	IUIola	IUIola	IUIola	IUIoU	IUIoU	IUIola	IUIoU	IUIoU	IUIoU
Ladevorschrift	Herstellervorgabe	Herstellervorgabe	Herstellervorgabe	Herstellervorgabe	Herstellervorgabe	Herstellervorgabe	Herstellervorgabe	Herstellervorgabe	Herstellervorgabe
Ladezeit	9h	12h	12h	10-11h	10-11h	13-14h	8-12h	7-10h	8-10h
Hauptladung I ₁	35,0A	35,0A	35,0A	32,4A	35,0A	35,0A	35,0A	15,0A	35,0A
U ₁	43,2V	43,2V	43,2V	42,3V	42,3V	42,3V	44,1V	44,1V	42,3V
t _{ic max} ¹⁾	7h	9h	10,5h	9h	9h	9h	14h	5,5h	---
t _{HLmax} ²⁾	10h	12h	12h	12h	12h	12h	19h	11h	16h
I _{um}	12,0A	15,7A	21,0A	2,9A	3,8A	3,8A	2,3A	1,5A	4,8A
Nachladung I ₂	12,0A	15,7A	21,0A	2,9A	3,8A	3,8A	2,3A	1,5A	---
U ₂	50,4V	50,4V	50,4V	50,4V	50,4V	50,4V	50,4V	44,1V	---
t _{NL}	1-4h 0,6 * t _{HL}	1-4h 0,6 * t _{HL}	1-4h 0,6 * t _{HL}	1-4h t _{NL} = t _{HL}	1-4h t _{NL} = t _{HL}	1-4h t _{NL} = t _{HL}	4h max U = 2,65V/Z	1h 20min fix	---
Ladeende I ₃	12,5A	15,7A	21,0A	2,9A	3,8A	1,9A	35,0A	1,5A	35,0A
U ₃	50,4V	50,4V	50,4V	41,4V	41,4V	50,4V	40,5V	44,1V	40,5V
t _{Aus}	8h ³⁾	8h ³⁾	8h ³⁾	---	---	12h	---	---	---
t _{Ein}	15min ³⁾	15min ³⁾	15min ³⁾	unbegrenzt	unbegrenzt	15h	unbegrenzt	unbegrenzt	unbegrenzt

HAKO#3635_1_SW0.85-2

¹⁾ Zwangsabschaltung / Fehlermeldung

²⁾ Zwangsumschaltung auf Nachladen (I₂)

³⁾ Zyklisch

Das Ladegerät startet die Ladung, wenn die Batteriespannung mindestens 0,2V pro Zelle beträgt. Dies geschieht unabhängig von einer erfolgreich aufgebauten Kommunikation mit der Hako-Maschinensteuerung („Notfallladung“ ist aktiv).

Sobald die Kommunikation mit der Hako-Maschinensteuerung aufgebaut ist, wird die reguläre Kennlinie gestartet. Ist dabei die Spannung noch unter 1,5V pro Zelle, wird eine „Softstart“-Phase durchlaufen. Dauert diese Phase länger als 30 Minuten, schaltet sich das Ladegerät mit einer Fehlermeldung ab.

In beiden Phasen („Notfallladung“ und „Softstart“) ist der Ladestrom auf 2A/100Ah begrenzt. Sind 1,5V pro Zelle erreicht, startet das Ladegerät die Hauptladung.

Table 6.5

6. Machine settings

6.1.7 Variant All wheel drive (X-AC)

The all-wheel drive variant must be activated here if it is present in the machine.

Chapter	Configuration	Content	Description	B175R
0	6		All wheel drive installed	
0	6	0	only Front wheel drive	d
0	6	1	Front- and Rear wheel drive	x

Table 6.6

6. Machine Adjustments

6.1.8 SD-storage medium in dash board

This parameter must not be adjusted. Can currently lead to a complete failure of the machine.

A missing SD-card in the dash board, leads to a “Blue-Screen” , that only displays the clock and the software version of the machine control system. The machine is inoperable.

Chapter	Configuration	Content	Description	B175R
0	7		additional memory at the display	
0	7	0	not available	x
0	7	1	available	d

Table 6.7

6. Machine adjustments

6.1.9 Logo on the start screen

The start logo can be selected here when the machine is switched on. A choice can be made between the "Hako" logo and the "Powerboss" logo.

For special customer requirements, a specific logo can be installed and activated via the special workshop.

Chapter	Configuration	Content	Description	B175R
0	8		Logo on the start screen	
0	8	0	Hako	d
0	8	1	PowerBoss	x
0	8	F	Specific Brand (SOW)	x

Table 6.8

6. Machine settings

6.2 Customer-specific settings (PPV)

Different settings can be carried out at the machine using the programmable programme variants.

It can, e.g., be set whether the last error that occurred in the machine is shown when turning on the machine or not.

Check and change the setting as described in Chapter 2.4 Configuration. The possible setting parameters are specified in the following table.

Depending on the software revision of the machine, not all the parameters will be visible or adjustable.

6. Machine settings

6.2 Customer-specific settings (PPV)

Chapter	Configuration	Content	Description	B175R
2	0		Last error indication after switching on machine	
2	0	0	Deactivate	x
2	0	1	Activate	d
2	1		Water level when switching on scrubbing	
2	1	0	Last stage set	d
2	1	1	Preset level (4)	x
2	3		Water level when switching on TOOL (menu option only appears when TOOL option is activated!)	
2	3	0	Last stage set	d
2	3	1	Preset level (4)	x
2	4		Speed-dependent water amount	
2	4	0	Deactivate	x
2	4	1	Activate	d

Table 6.9 a

6. Machine settings

6.2 Customer-specific settings (PPV)

Chapter	Configuration	Content	Description	B175R
2	5		BlueSpot always On (drive pedal neutral)	
2	5	0	Deactivate	d
2	5	1	Activate	x
2	7		Silence Mode Setting	
2	7	0	Is not saved	x
2	7	1	Is saved	d
2	8		Acoustic Alarm Tone Interval (menu option only appears when the Acoustic Alarm option is activated!)	
2	8	0	Standard	d
2	8	1	Alternative	x
2	B		Highest water stage independent from machine speed	
2	B	0	No	d
2	B	1	Yes	x

Table 6.9 b

7. Mechanical components

7.1 Squeegee

Squeegee connection

Installation note:

1. Hook squeegee connection into chassis.
2. Align parallel to floor and tighten bolts.

Squeegee connection default setting:

1. For default setting of adjusting bushing see figure 7.1 (dimensions 9 and 8 mm).
2. Screw on the squeegee which is intended for the machine and align via the adjusting bushing so that the sealing strips are vertical against the floor (lift slightly and allow to fall).
3. Align castors using the method shown and adjust them so that they are 7 mm above the ground.
4. If necessary, adjust the squeegee inclination to the ground conditions.

7. Mechanical components

7.1 Squeegee

Squeegee connection

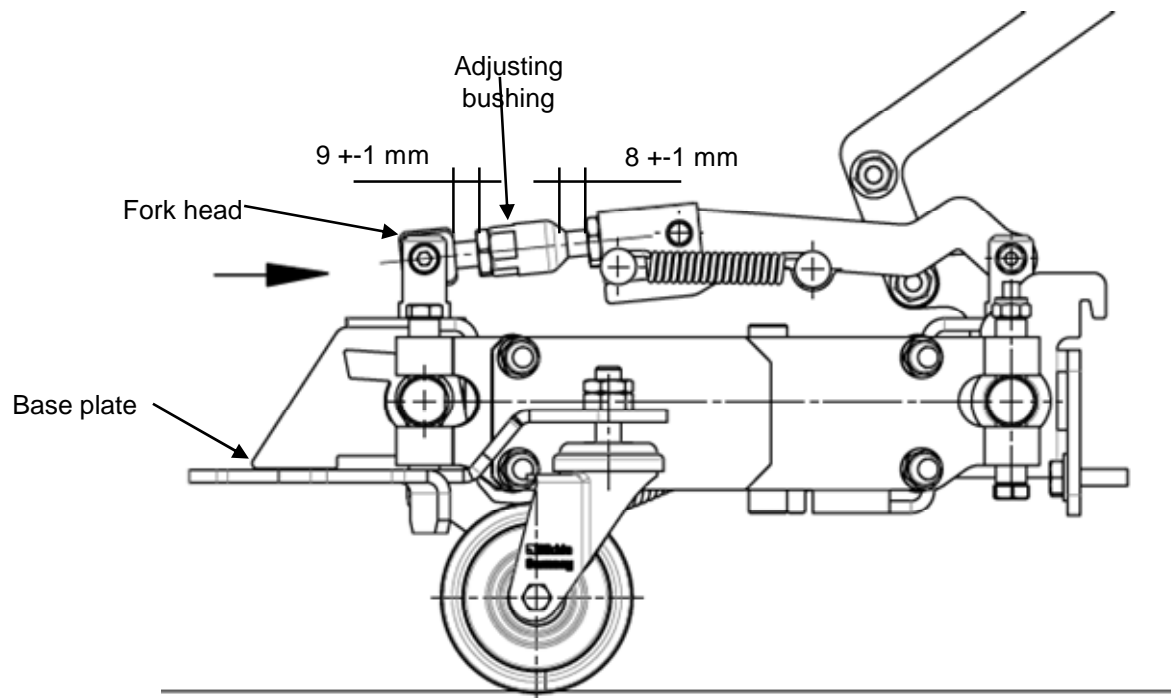

Figure 7.1

7. Mechanical components

7.1 Squeegee

Adjusting the sealing strips / inclination

The correct inclination adjustment is decisive for:

- ensuring that the sealing strips of the squeegee are lying evenly on the ground over their contact surface
- ensuring that the squeegee runs quietly and evenly during the suction process.

1. Place the machine on a level surface and lower the squeegee using the squeegee key figure 7.2b -46.

2. Loosen the lock nuts (figure 7.2a-A) and adjust the squeegee by turning the adjusting bushing (figure 7.2a-B) so that the ends of the sealing strips are just about touching the ground.

Turning the adjusting bushing clockwise:

The distance between the sealing strip and the ground increases at the ends figure 7.2a.

Turning the adjusting bushing counter-clockwise:

The distance between the sealing strip and the ground decreases at the ends figure 7.2b.

3. Turn on the machine and check the suction pattern. When driving, the sealing strips must be turned over evenly everywhere (centre and outside).
4. Tighten the lock nuts.

7. Mechanical components

7.1 Squeegee

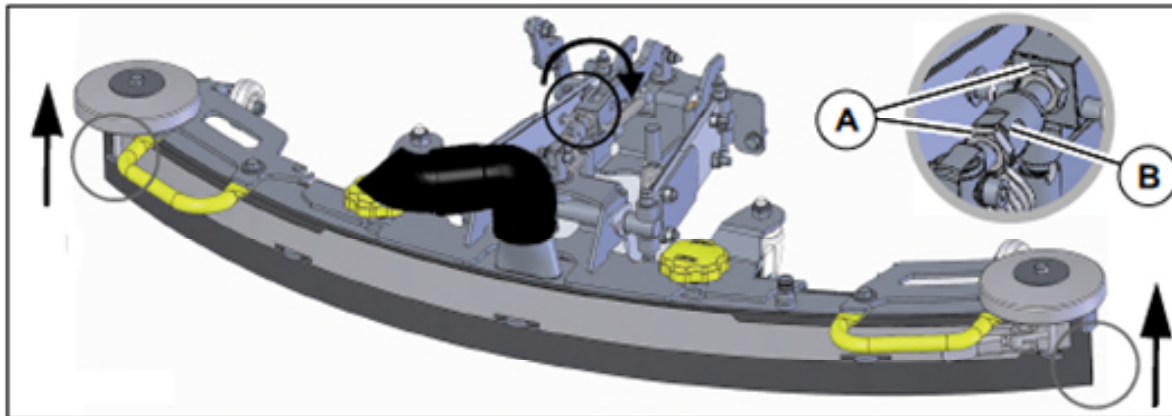

Figure 7.2a

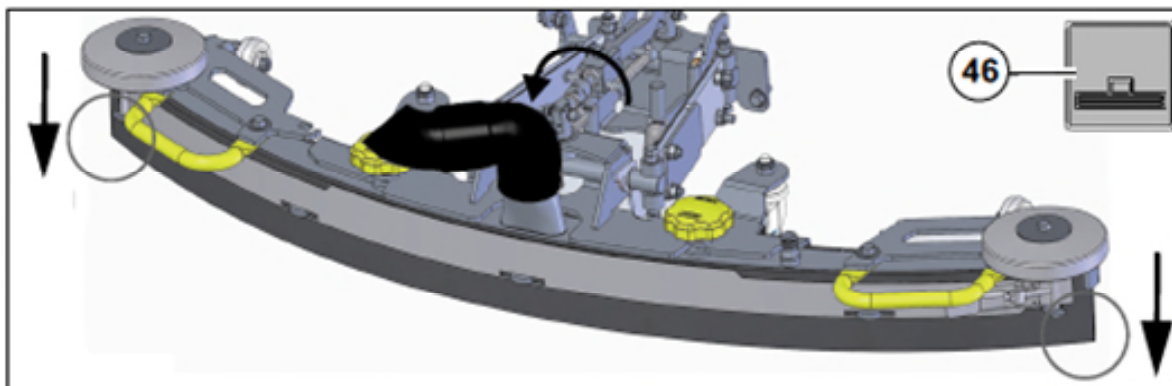

Figure 7.2b

7. Mechanical components

7.1 Squeegee

Height adjustment

The height adjustment (X) of the supporting rollers Fig. 7.4 has been set to 7 mm in the factory. If striping still occurs despite optimum inclination adjustment, readjust the distance between the supporting rollers and the lower edge of the sealing strip.

1. Place the machine on a level surface.
2. Lower squeegee. The sealing strips must now be resting vertically onto the floor.
3. Loosen nuts (figure 7.4 B) and adjust distance between supporting roller and ground as per the table.
4. Tighten nuts.

Distance from floor (X)	Use
<7 mm	Very smooth floor surfaces, e.g. coated screed, PVC, linoleum
7 mm	Standard setting
>7 mm	Very uneven floor surfaces, e.g. poorly laid tiles (water does not drain off)

Figure 7.3

7. Mechanical components

7.1 Squeegee

Height adjustment

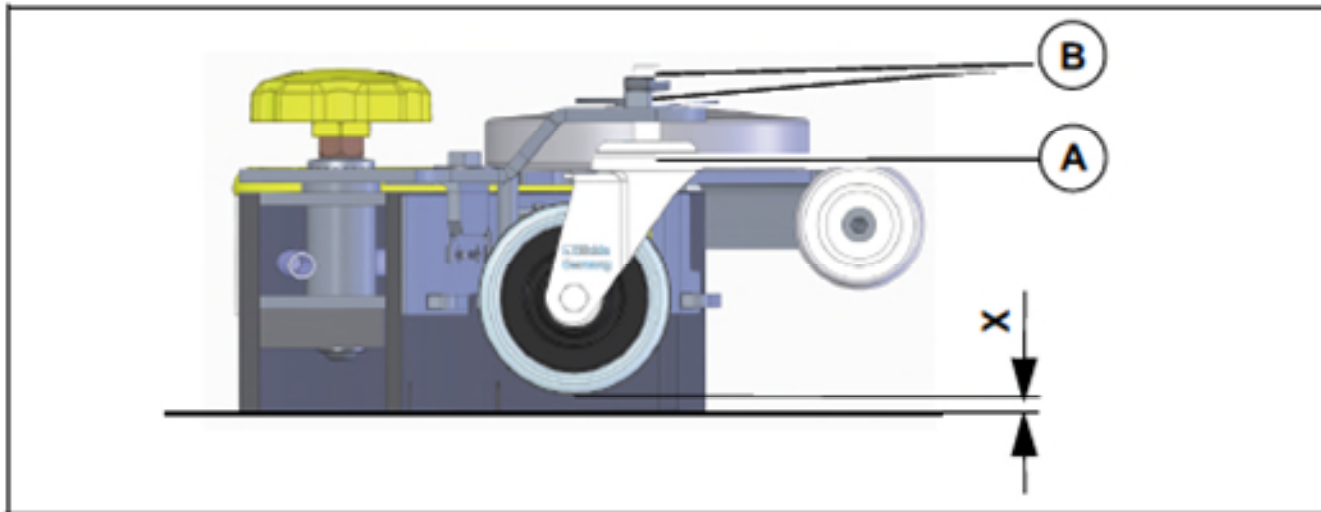

Figure 7.4

7. Mechanical components

7.2 Plate brush heads

Plate brush heads in two working widths (90 cm and 108 cm) are used with the Scrubmaster B175 R.

Both brushes are driven by a separate motor.

The left and right brushes on the plate brush unit both rotate clockwise. This is needed for automatic brush decoupling and automatic threading.

7. Mechanical components

7.3 Cylindrical brush heads

A deck with a working width of 85 cm is used as the cylindrical brush unit for the Scrubmaster B175 R.

The cylindrical brush unit can also be extended with a side broom unit.

Use the guide rail to adjust the dirt hopper ensuring the brush strip is positioned all-round on the housing and the dirt hopper can still be slightly inserted.

7. Mechanical components

7.4 Brush head lifting

7.4.1 Potentiometer in the lifting element for the brush head

The lifting element for the brush head features integrated position detection. The position detection is supplied with 24V via the machine control unit A01.X13:1 (+) and A01.X13:7 (-). The reference signal for the brush head position can be measured against supply plus or minus at the central control unit at A01.X15:5.

This Signal must be between 0.3V and 2.3V. Voltage values outside this value range are recognised as errors and output with message 1.2.6.3.

This message is also output if the "ACTUAL" signal of the position detection does not correspond to the "SET" value within a defined time.

The power output of the lifting element is A01.X11:1 and 4.

8. Water pump

The water pump for supplying the operative units is connected at the central control unit at A01.X12:1 + 11. It is operated via a clocked voltage to deliver different quantities of water for the stages. The voltage values measured here depend on numerous factors; it is therefore not possible to specify exact values. Decisive is that the voltage values differ considerably from the lowest to the highest stage.

Checking of the actual water quantities is preferable.

During the voltage measurement it must be taken into consideration whether the dependence of the water quantity on the travel speed has been activated. This can be activated by the operator in menu item "Maintenance".

8. Water pump

8.1 Water supply – Position of the components on the water plate

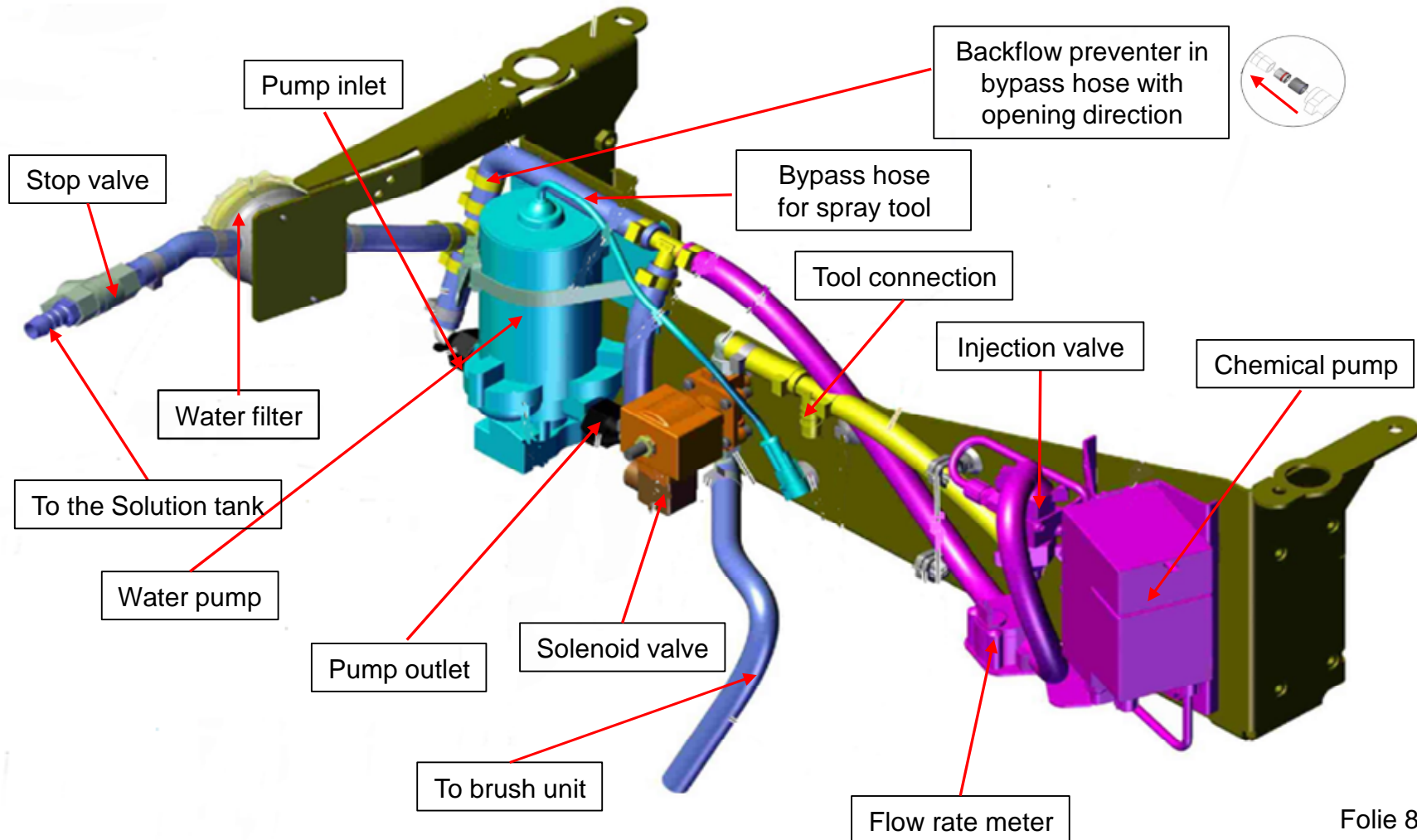

8. Water pump

8.2 Water quantities

The water quantities in the 5 water stages for the three brush units are listed in the following table.

	Water quantities (l per min)		
	Plate brush 900 mm	Plate brush 1080 mm	Roller brush 850 mm
Stage 1	1.6	1.6	1.3
Stage 2	3	3	2.4
Stage 3	4.5	4.5	3.6
Stage 4	5.9	5.9	4.7
Stage 5	7.3	7.3	5.8

8. Water pump

8.3 Water pump standstill detection

If the pump cannot delivery freely because the water cannot run freely through the hoses to the brush, so-called water pump standstill detection comes into effect.

Automatic water pump standstill detection:

The electronics offers the option to protect the water pump if the pump can no longer convey freely.

This means: If the pump sucks water from the tank but cannot further convey the water to the brushes, pressure builds up behind the pump.

Without protection from the electronics, the pump will now continue to pump against this pressure and may be damaged.

The electronics detects that the pump cannot convey freely and automatically switches the pump OFF for 2 seconds.

After these 2 seconds have expired, the pump is briefly switched back on while simultaneously measuring whether the pump can now convey freely again or whether the water supply to the brushes is still blocked.

If the pump can convey freely, it remains switched on in the selected stage.

If there is, however, still counter pressure, the pump is switched off again for 2 seconds.

This is repeated until the error has been eliminated.

8. Water pump

8.4 Scrubbing/suction tool and spray tool

The scrubbing/suction tool and the spray tool are options which can be installed in the machine and then have to be activated in the machine control unit.

The spray tool requires a greater quantity of water so that a sufficient jet of water comes out of the spray nozzle. In order to do this, the water pump is actuated with a high voltage in order to obtain a sufficient delivery quantity. This can lead to the system pressure increasing so much that the solenoid valve is opened by the water pressure. To prevent this, a bypass must be installed between the water pump outlet and the inlet which contains a valve which opens at a pressure of about 2 bar.

9. Drive

The drive control features its own diagnostics and a self-test.

Therefore, the function of the drive control unit is locked when turning on the machine if the speed control potentiometer isn't in neutral or is not recognised as being in neutral position.

The same behaviour applies after the seat contact switch has opened and is closed again.

The speed control potentiometer must also be in neutral when the seat contact switch is closed, or to be more precise it must be detected as being in neutral by the drive control unit.

If the drive control unit does not recognise that the speed control potentiometer is in neutral, it shows flashing signals (LED) at the drive control unit.

These messages are transferred to the machine control unit via the CAN bus, where they are evaluated. For front- and Rear drive motor, different drive control modules are used. The drive control units must not be mixed up.

9. Drive

9.1 DMC drive control unit - Front

The DMC drive control unit features a diagnostic input. Unless clearly noted in the service documents, changes to the preset values and parameters is generally **not** permitted. Currently, only the diagnostics with flash codes for the LED indicator is used.

9.1.1 Connection description:

M1; M2; M3 – motor connections

B+; B- – battery power supply

A – control connections (16-pole)

B – programming plug CAN bus (8-pole)

C – motor feedback (6-pole)
(encoder and temperature)

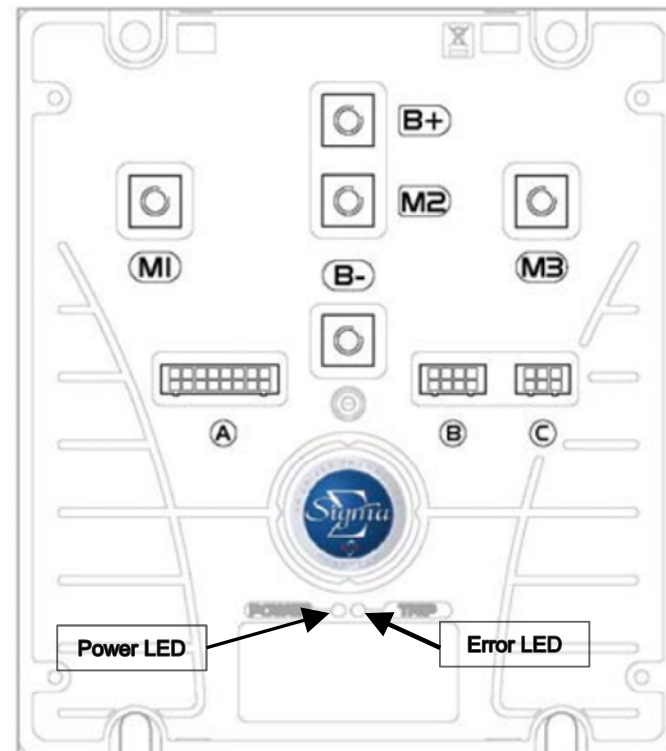

Figure 9.1

9. Drive

9.1.1 Connection description – drive control unit Front

- A1 – forwards (active when B- is connected) from A02:X109.3
- A2 – reverse (active when B- is connected) from A02:X109.4
- A3 – release for driving from speed control potentiometer switch B03 (active when B- is connected)
- A4 – release from machine control unit (active when B- is present) from A01/X13.11
- A5 – not used
- A6 – with single wheel drive at battery minus via bridge on X11/ not used for 4-wheel drive
- A7 – foot brake input from switch S10; if B- is connected, the machine is slowed down until standstill
- A8 – supply speed control B03 (negative)
- A9 – setpoint from speed control B03
- A10 – control voltage from key switch (36V)
- A11 – control power supply for small consumers (max. 3A) (e.g. K02 and brake)
- A12 – main relay release (B-) –K02 – power supply for drive control unit
- A13 – brake release (B-)
- A14 – not used for single wheel drive / safety control from A05:C3 with 4-wheel drive
- A15 – 12 V supply for encoder
- A16 – 5 V supply for speed control B03

9. Drive

9.1.2 Service codes DMC control unit -Front

Code	Error description	Cause	Remedy
Warning - reduces the output, resets itself (if possible).			
1	Not used	--	--
2	Low voltage	Low battery voltage (<18 V)	Charge the battery
3	Not used	--	--
4	High voltage	High battery voltage (usually during braking) (U> 60 V)	Extreme downwards travel (pay attention to machine specifications) defective battery?
5	Hot drive motor	Vehicle used outside the specification? Is the motor OK?	Let the motor cool down
6	Hot control unit	Vehicle used outside the specification? Are the control unit and cooling OK?	Allow drive control unit to cool down
7	Parameters outside the permissible range	One or several parameters are outside the valid range	Replace the control unit
8	Standard parameters loaded	Standard parameters have been loaded	If error persists, replace drive control unit.

9. Drive

9.1.2 Service codes DMC control unit - Front

Code	Name	Description	Remedy
Drive error faults -Commences gracefull neutral brake - requires a neutral recycle action to reset fault			
9	Memory chip fault	Memory not accessible	Internal voltage <12V; replace Drive Control Unit
10	2 directions active	forward and Reverse direction active	Check the wiring of the direction switch (-A02.X6 and -A04.A1/A2)
11	Seat switch not closed or timed out	No release signal from Machine Control Unit	Check the wiring from -A01.X13:11 to -A04.A4 (should be connected to battery minus)
12 S01	Wrong Power Up sequence	Forward, Reverse or FS1 (-A04.A3) active before key switch on	Pay attention to the starting sequence: key switch / seat switch, direction switch, potentiometer switch.
12 S02	Wrong Power Up sequence	Rear Controller Anti Roll back at ramp and active brake	Check the EM brake of teh rear axle
12 S03	Wrong Power Up sequence	Rear controller micro switch on EM brake is active	Check deactivation of rear motor EM brake
13	Accelerator signal is active at Power Up	Speed signal is >50% at power up	Check potentiometer and it's wiring
14	CAN-Bus	Stop via CAN	Machine Control unit send Stop Signal via CAN-Bus e.g. machine is blocked, when seat switch is open

9. Drive

9.1.2 Service codes DMC control unit - Front

Code	Name	Description	Remedy
Soft error faults - immediately stops pulsing - Requires a neutral recycle action to reset fault			
15	Low voltage	internal 12V supply too low	Check charging level of the battery
16	Not used	--	--
17	Low voltage	Battery voltage too low	Check charging level of the battery
18	High Side Mosfet short circuit	Short circuit to battery plus	Check Motor insulating; Faulty Drive Control Unit.
19	Front Controller has no error, but rear controller has a fault	--	Check service message of the rear controller

9. Drive

9.1.2 Service codes DMC control unit - Front

Code	Name	Description	Remedy
Hard Error Faults - Immediately stops pulsing and open line contactor - Cannot be reset (only by a key switch recycle)			
20	Hardware over current trip	Motor Over current	Check Motor and Motor wiring
21	Contactor Coil driver fault	Coil of Line Contactor or Magnetic Brake short circuit	Check Line contactor (-K02) and Magnetic Brake(-M01)
22	Battery Voltage is too high	Voltage > 67V	Excessive downhill ride?
23	Mosfet short circuit in neutral	Low side Mosfet short circuit in neutral position	Check Motor Insulation, if OK, replace drive Control Unit
24	Hardware Fail safe fault	Hardware safety problem	Check wiring. Replace Drive Control Unit.
25	Line Contactor failure	Relais Contacts of -K02 are not closed within it's time Specification	<p>Check the wiring of the line contactor (-K02)</p> <p>Battery Voltage too low?</p> <p>E-stop in Key switch circuit is active</p> <p>Difference in the voltage between A04.B+ and A04.A10 during start up check</p> <p>Open circuit from B+ to B- (Fuse -F03)</p>

9. Drive

9.1.2 Service codes DMC control unit - Front

Code	Name	Description	Remedy
Hard Error Faults - Immediately stops pulsing and open line contactor - Cannot be reset (only by a key switch recycle)			
26	Not used	--	--
27	Mosfet shortcircuited to battery minus	Mosfet shortcircuited to battery minus before Line Contactor is closed	Check insulating of the motor. If ok, replace the Drive Control Unit
28 S01	Wire off	Motor Phase Connection	Check Wiring -A04 <=> -M01
28 S02	Wire off	Magnetic Brake short circuit	Check Wiring
28 S03	Wire off	Magnetic Brake wire off	Check Wiring
28 S04	Wire off	Speed sensor wire off	Check Wiring
28 S05	Wire off	Accelerator Wire off	Check Wiring of Hall Sensor -B03
28 S06	Wire off	Motor Thermistor Wire off	Check Wiring

9. Drive

9.1.2 Service codes DMC control unit - Front

Code	Name	Description	Remedy
Hard Error Faults - Immediately stops pulsing and open line contactor - Cannot be reset (only by a key switch recycle)			
29	CAN Error Front		
29 S01	CAN Fehler	Front controller Timeout	Check CAN-Bus connection
29 S02	CAN Fehler	Front controller security bit error	Check CAN-Bus connection
29 S03	CAN Fehler	Timeout Front Controller and Machine controller	Check CAN-Bus Drive controller
29 S04	CAN Fehler	Data error machine control unit	Check CAN-Bus Drive controller front and machine control unit
29 S05	CAN Fehler	Data error machine control unit	Check CAN-Bus Drive controller front and machine control unit
30	Over speed	Overspeed or Speed sensor failure	Check the speed sensor

9. Drive

9.1.3 Brake – manual release of the brake - Front

In order to also move the machine without a power supply (no battery installed or other drive problems), the magnetic brake can be released manually.

In order to push the machine, carry out the following steps:

1. Loosen the bolts of the cover to the drive using the supplied socket wrench and remove the cover.
2. Remove the pin **Fig. 9.2-A** from the holder and screw it into the ring **Fig. 9.2-B**.
3. In order to unlock the parking brake, slightly pull the pin upwards **Fig. 9.2-C** and simultaneously push the machine.
4. Disassembly is in reverse order.

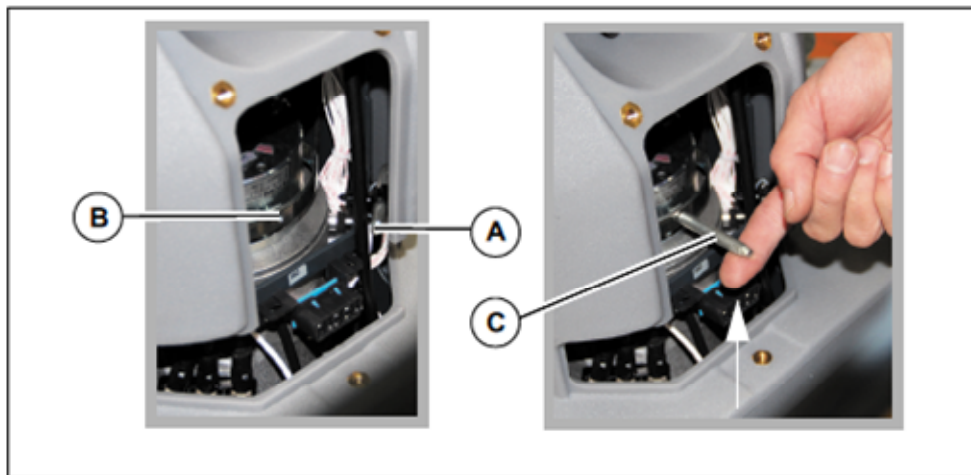

Figure 9.2

9. Drive

9.1.4 Brake – testing the brake function

The brake must be capable of stopping the machine on a level road within 0.19 m per km/h.

At a maximum speed of 8 km/h, this means that the maximum braking distance must not exceed 1.52 m. Check this after carrying out work at the brake system and as part of regular maintenance.

This value must be achieved when actuating the brake tip switch S10.

The service brake function of the SCM B175R is realised exclusively via the drive control unit.

The magnetic brake on the motor is only the parking brake.

9. Drive

9.2 DMC drive control unit - Rear

The communication between the drive control unit Front (-A04) and the drive control unit Rear (-A05), is only via CAN-Bus. The two drive control unit have different parameter sets, Therefore the never have to be exchanged.

9.2.1 Connection description:

M1; M2; M3 – motor connections

B+; B- – battery power supply

A – control connections (16-pole)

B – programming plug CAN bus (8-pole)

C – motor feedback (6-pole)
(encoder and temperature)

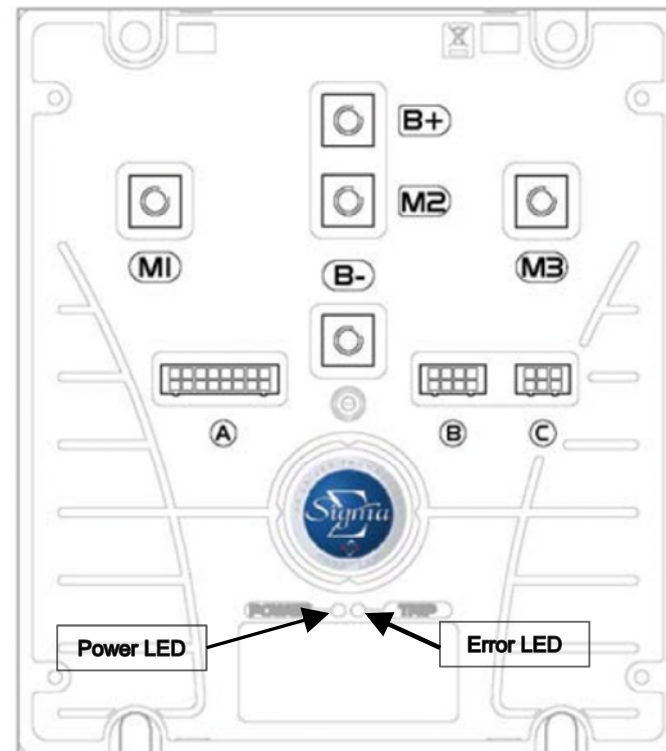

Figure 9.3

9. Drive

9.2.1 Connection description – drive control unit Rear

A1 – not used

A2 – not used

A3 – not used

A4 – release from machine control unit (active when B- is present) from A01/X13.11

A5 – not used

A6 – micro switch from magnetic brake;

Drive control unit is deactivated, if the brake is manually released (active, if B- is present)

A7 – not used

A8 – supply steering angle sensor R20 (negative)

A9 – setpoint from steering angle sensor R20

A10 – control voltage from key switch (36V)

A11 – control power supply for small consumers (max. 3A) (e.g. K03 and brake)

A12 – main relay release (B-) –K03 – power supply for drive control unit

A13 – brake release (B-)

A14 – not used

A15 – 12 V supply for encoder

A16 – 5 V supply for steering angle sensor R20

9. Drive

9.2.2 Service codes DMC control unit - Rear

Code	Name	Description	Remedy
Controller warning faults - Reduces only performance - Fault will reset itself (if possible)			
1	Not used	--	--
2	Low Voltage	Low Battery voltage (U < 18V)	Charge battery
3	Not used	--	--
4	High Voltage	High Battery Voltage (typically during braking) (U > 60V)	Defective Battery? Excessive downhill ride?
5	Drive Motor overheated	Machine is used outside it's specification?	Cool down the drive motor
6	Drive Control Unit overheated	Machine is used outside it's specification? Cooling of the Drive Control Unit ok?	Cool down the Drive Control Unit
7	Parameters out of specification	One or more parameters out of it's specification	Replace the Drive Control Unit
8	First Power Up	Default parameters restored in FRAM	If permanent error, replace Drive Control Unit

9. Drive

9.2.2 Service codes DMC control unit - Rear

Code	Name	Description	Remedy
Drive error faults -Commences gracefull neutral brake - requires a neutral recycle action to reset fault			
9	Memory chip fault	Memory not accessible	Internal voltage <12V; replace Drive Control Unit
10	2 directions active	Forward and Reverse direction active	Check the wiring of the direction switch (-A02.X6 and -A04.A1/A2)
11	Seat switch not closed or timed out	No release signal from Machine Control Unit	Check the wiring from -A01.X13:11 to -A05.A4 (should be connected to battery minus)
12	Wrong Power Up sequence	Forward, Reverse or FS1 (-A04.A3) active before key switch on	Pay attention to the starting sequence: key switch / seat switch, direction switch, potentiometer switch.
13	Accelerator signal is active at Power Up	Speed signal is >50% at power up	Check potentiometer and it's wiring
14	Not used	--	--

9. Drive

9.2.2 Service codes DMC control unit - Rear

Code	Name	Description	Remedy
Soft error faults - immediately stops pulsing - Requires a neutral recycle action to reset fault			
15	Low voltage	internal 12V supply too low	Check charging level of the battery
16	Safety line error	Drive control rear is ok	Error from drive control front; (-A04.A14 => -A05.C3)
17	Low voltage	Battery voltage too low	Check charging level of the battery
18	High Side Mosfet short circuit	Short circuit to battery plus	Check Motor insulating; Faulty Drive Control Unit.
19	Not used	--	--

9. Drive

9.2.2 Service codes DMC control unit - Rear

Code	Name	Description	Remedy
Hard Error Faults - Immediately stops pulsing and open line contactor - Cannot be reset (only by a key switch recycle)			
20	Hardware over current trip	Motor Over current	Check Motor and Motor wiring
21	Contactor Coil driver fault	Coil of Line Contactor or Magnetic Brake short circuit	Check Line contactor (-K03) and Magnetic Brake (-M02) and it's wiring
22	Battery Voltage is too high	Voltage > 67V	Excessive downhill ride?
23	Mosfet short circuit to Batt minus	Low side Mosfet short circuit in neutral position	Check Motor Insulation, if OK, replace drive Control Unit
24	Hardware Fail safe fault	Hardware safty problem	Check wiring. Replace Drive Control Unit.
25	Line Contactor failure	Relais Contacts -K03 are not closed within it's time Specification	<p>Check the wiring of the line contactor (-K03)</p> <p>Battery Voltage too low?</p> <p>E-stop in Key switch circuit is active</p> <p>Difference in the voltage between -A05.B+ and -A05.A10 during start up check</p> <p>Open circuit from B+ to B- (Fuse -F04)</p>

9. Drive

9.2.2 Service codes DMC control unit - Rear

Code	Name	Description	Remedy
Hard Error Faults - Immediately stops pulsing and open line contactor - Cannot be reset (only by a key switch recycle)			
26	Not used	--	--
27	Mosfet shortcircuited to battery minus	Mosfet shortcircuited to battery minus before Line Contactor is closed	Check insulating of the motor. If ok, replace the Drive Control Unit
28 S01	Wire off	Motor Phase Connection (Rear)	Check Wiring -A05 <=> -M02
28 S02	Wire off	Magnetic Brake short circuit (Rear)	Check Wiring
28 S03	Wire off	Magnetic Brake wire off (Rear)	Check Wiring
28 S04	Wire off	Speed sensor wire off (Rear)	Check Wiring
28 S05	Wire off	--	--
28 S06	Wire off	Motor Thermistor Wire off (Rear)	Check Wiring
29	CAN Error Rear		Only in AWD
29 S01	CAN Error Rear	Rear controller Time Out	No response from Drive control; Check wiring of CAN
29 S02	CAN Error Rear	Rear controller security bit error	Check the CAN-Bus
30	Overspeed	Overspeed or sensor fault	Check Parameters and the speed sensor

9. Drive

9.2.3 Brake at the Rear axle

If the machine is equipped with the X-AC-Drive system, additionally the brake at the rear axle has to be unlocked. Lift the lever on the right side of the machine, next to the rear wheel, till it snaps into place (Figure 9.4 A).

When the rear brake is disengaged, a indication in the MFD is displayed (Figure 9.4 B).

Now the machine is out of operation. To reactivate the machine, lower the brake lever.

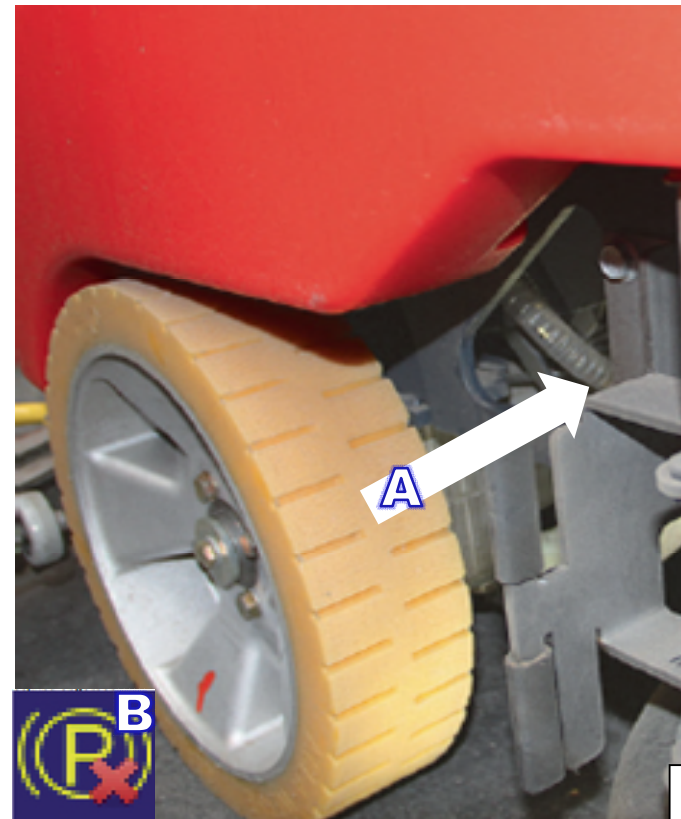

Figure 9.4

9. Drive

9.2.4 Steering angle sensor

In All wheel drive mode, the speed of the rear axle has to be adapted to the steering angle of the front wheel drive.

For this reason a rotary sensor is installed at the front wheel drive. After the sensor is replaced, the sensor may need accurate adjustment.

The procedure is described on the following page.

Figure 9.5 indicates the positions of all components; Table 9.1 is a list of this components.

9. Drive

9.2.4 Steering angle sensor

Steps for adaption of the steering angle sensor (PN 01372660) to the drive motor (PN 01371270)

Instruction

Bring the front wheel to center position.

Install the Bushing pos. 100 in the Flange plate.

Put the shaft pos. 20 in the bushing pos. 100.

Align the key groove of the shaft transverse to the driving direction.

Press the washer pos.150; spur gear pos.110 und washer pos.170 to the shaft. (with a threaded rod or a long screw)

Fit Screw pos.130 and washer pos.180. (with threadlocker e.g. Loctite 243) (Tightening torque 9.3 Nm)

Install the feather key pos.200 and grease the upper end of the shaft as a corrosion protection. (e.g. Mobilgrease MB2)

Install the potentiometer (PN 01372660) at the Base plate (Pos. 10) and screw together. Attention!

Install the sensor shaft in center position (2.5 turns in both direction possible)! Tightening torque 1,5 Nm.

Install the base plate (pos.10) with the potentiometer and fix it with the screw pos.120. (with threadlocker e.g. Loctite Tightening torque 9.3 Nm)

Check Ohms resistance at Pin 2 and Pin 3 of the plug of the potentiometer (2,5 kOhm)

9. Drive

9.2.4 Steering angle sensor

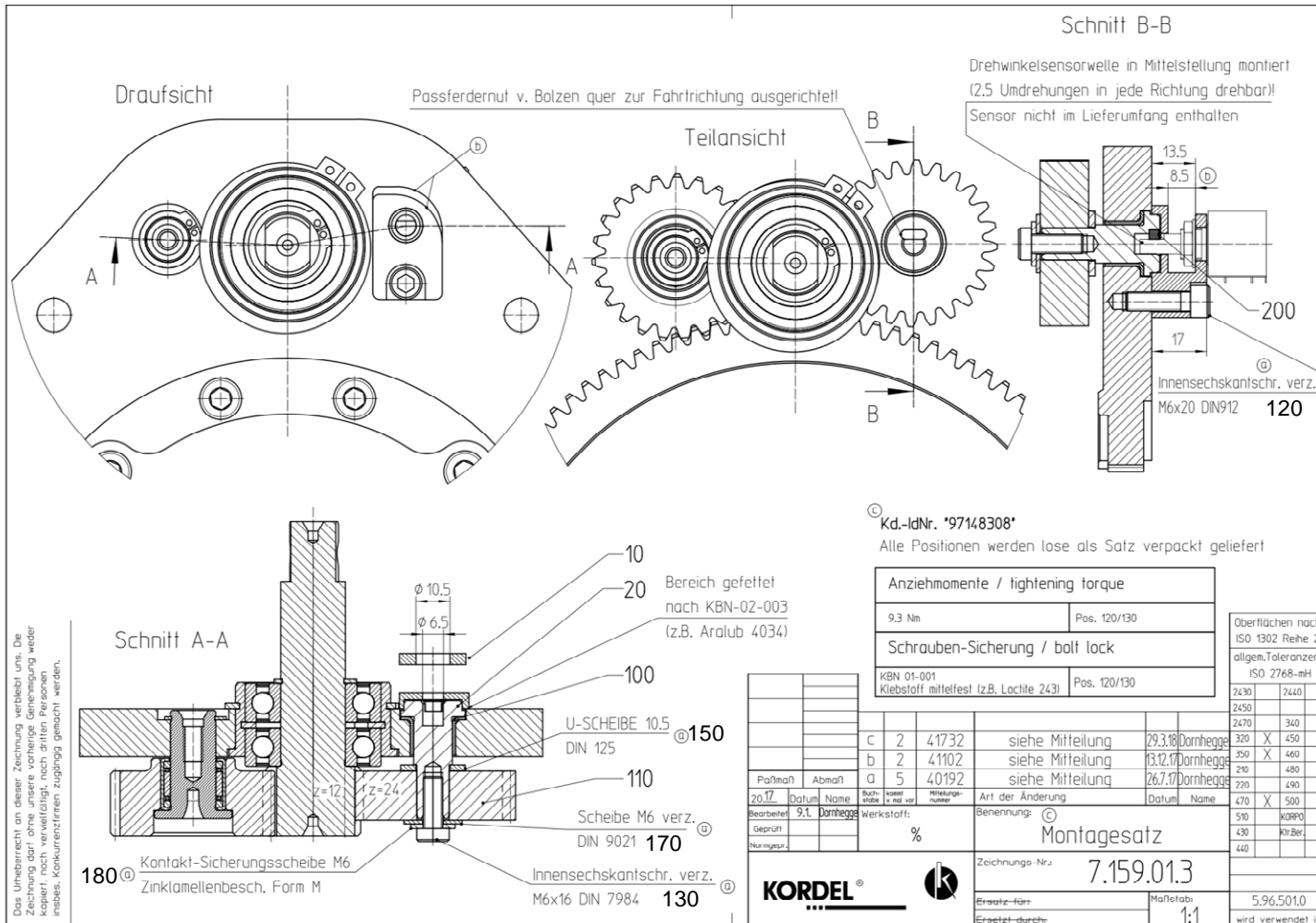

Figure 9.5

9. Drive

9.2.4 Steering angle sensor

Parts List

Pos	Kordel-No.	Description	Description 2	Amount	Length	Unit
10	71.0565.4	Base plate sensor		1	0	Pc.
20	64.0402.4	Shaft		1	0	Pc.
100	143 1214121	Flange bushing	Normal	1	0	Pc.
110	164 0000178	Spur gear	M =2 / Z = 24	1	0	Pc.
120	307 0602041	Screw M6x20 DIN 4762	8.8 Verzinkt	1	0	Pc.
130	309 0601641	Screw M6x16 DIN 7984	8.8 Verzinkt	1	0	Pc.
150	400 0105201	Washer 10.5 DIN 125	Verz.	1	0	Pc.
170	406 0064000	Washer 6.4 DIN 9021		1	0	Pc.
180	413 0006315	Lock Washer 6	ZK. LAM. Form M	1	0	Pc.
200	440 0300800	Feather key A 3x3x8 DIN 6885		1	0	Pc.

Table 9.1

10. Service messages

Service-Code	Description	Remedy
1.2.5.1.	Thermo switch brush motor 1 (left)	Check current consumption of brush motor (-M03) and wiring of the thermo switch
1.2.5.2.	Thermo switch brush motor 2 (right)	Check current consumption of brush motor (-M04) and wiring of the thermo switch
1.2.6.1.	Brush motor 1 (left) overload	Short circuit in the brushmotor (-M03) or in it's wiring; Brush motor overload
1.2.6.3.	Lifting element brush deck	Overload of the brush deck lifting element or short circuit
1.2.6.8.	Brush motor 2 (right) overload	Short circuit in the brushmotor (-M04) or in it's wiring; Brush motor overload
1.2.6.B.	Switch position SW800 on A01 (Master-Control unit) doesn't match the selected brush deck in parameter 0.2.X.	Check the switch position of switch SW800 on the A01 board. This adjustment must correspond to the selected brush deck (Plate brush or Cylindrical brush). (see chapter 6.1.1.)
1.4.6.1.	Lifting element squeegee	Overload of the squeegee lifting element; short circuit
1.4.6.3.	Blocking protection Suction motor 1	Short circuit in the suction motor (-M16) or in it's wiring
1.4.6.4.	Blocking protection Suction motor 2	Short circuit in the suction motor (-M17) or in it's wiring
1.5.5.1.	Malfunction Filling sensor solution tank (B06)	Sensor value out of it's range; recalibrate the sensor

10. Service messages

Service-Code	Description	Remedy
2.2.5.1.	Thermo switch broom motor	Current consumption broom motor and wiring thermo switch (option pre sweep)
2.3.5.1.	Thermo switch side broom motor left and right	Current consumption side broom motors and wiring thermo switches (option side broom)
2.3.6.1	Blocking protection side broom motor left and right	Short circuit in the side broom motors or in it's wiring (option side broom)
2.3.6.4.	Blocking protection side broom lifting element	Lifting element side broom overloaded (option side broom)
3.1.1.2.	Fleetrekorder communication interruption	Check wiring between machine control unit and Fleetrekorder (A01.X20)
3.1.5.2.	Additional power supply during charging	During charging process; Invalid power supply in Key switch circuit
3.1.6.E.	Power fuses (group signal)	Check fuses on the -A01 board, The voltage between -A01.X1 and -A01.X2 is insufficient
3.2.6.5.	Backup battery weak	Replace backup battery; Type CR2032
3.2.6.6.	Backup battery empty	Replace backup battery; Type CR2032

10. Service messages

Service-Code	Description	Remedy
3.3.1.1.	Service intervall expired	Reset the service interval with the Hako diagnosis
3.3.1.5.	SD-Card on the Display	re flash the SD-card with the diagnosis system, if error repeats, replace the SD-card with a new one
3.3.6.2.	Group signal low power output overload	Overload of small cosumer outputs (e.g. buzzer, magnetic valve. Etc.)
3.4.1.1.	pre selection of driving direction implausibly or interrupted wiring accelerator	Check direction switches on the Dash board; Message is generated by the operator panel (-A02)
3.4.1.2.	Malfunction drive control unit front	see blinking code on drive control unit
3.4.1.3.	Drive control front general	Configuration of the machine control unit (0.6.X) Singel-Drive / All-Wheel drive doesn't match the wiring variant of the machine; connector X11 - jumper X11.7 / 8 only for single drive machines.
3.4.1.4.	Malfunction drive control unit rear	see blinking code on drive control unit
3.4.5.1.	over temperature drive motor front	check the wiring of the drive motor thermo switch. Is the machine used outside it's specification?
3.4.5.2.	over temperature drive motor rear (Option 3-wheel drive)	check the wiring of the drive motor thermo switch. Is the machine used outside it's specification?
3.4.5.b.	over temperature drive motor rear (Option 3-wheel drive)	See blinking code at the drive control unit; check the wiring of the drive motor thermo switch. Is the machine used outside it's specification?
3.6.6.4.	Seat contact switch manipulation	See chapter 2.2.3.

10. Servicemeldungen



Service-Code	Description	Remedy
4.1.3.1.	Communication problem drive control unit front	CAN-Bus-error between machine control unit and drive control unit (-A01 => -A04)
4.1.3.2.	Communication problem drive control unit front	CAN-Bus-error between machine control unit and drive control unit (-A01 => -A04)
4.2.3.1.	Communication problem drive control unit rear	CAN-Bus-error between machine control unit and drive control unit (-A01 => -A05)
4.5.2.1.	Communication problem battery charger	CAN-Bus-error between machine control unit and battery charger (-A01 => -G10)
4.5.2.5.	Display communicatin problems	Communication between display and control unit is interrupted. Message is generated by the display during switching on of the machine. Is it possible to connect the control unit with the hako diagnosis?
4.5.3.5.	Display communicatin problems	Communication between display and control unit interrupted. Message is generated by the display. Appears during operation of the machine. Is it possible to connect the control unit with the hako diagnosis?

10. Service messages

Service-Code	Description	Remedy
4.6.1.2.	Internal malfunction of machine control unit	Replace the control unit (-A01)
4.6.1.3.	Malfunction of internal software	Replace the control unit (-A01)
5.8.7.1.	Malfunction battey charger-charger related problems.	See battery charger manual - Malfunction
5.8.7.2.	Malfunction battey charger-battery related problems.	See battery charger manual - Malfunction
5.8.7.3.	Battery charger; Wrong charging characteristic adjusted	Charging characteristic of the battery charger doesn't match the selected Charging charakteristic in the display.
5.8.7.4.	Charging configuration of the machine control system doesn't match the charger	Only during the charging. Problems in the Communication with the display. Stop the charging; operate the machine for minimum 10 sec; switch off the machine and restart the charging.
7.1.5.1.	USB-Output low voltage	Short circuit at the output; Overload of the USB Output

10. Service messages

10.1 Meaning of different switch on displays

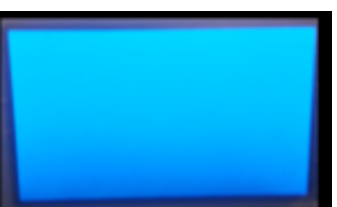
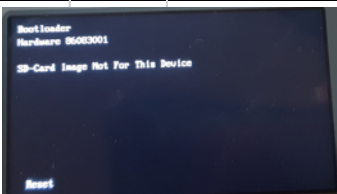
	<p>1.) Display at missing SD-Card in Dash board (Blue-Screen with time and Servicecode)</p>
	<p>2.) Display, when the operating system at the machine control system is missing, isn't started or the CAN-connection between machine control unit and dash board is interrupted (permanent).</p>
	<p>Both: 1.) and 2.) did occur. (Blue-Screen)</p>
	<p>3.) A SD-Card was inserted in the dash board. This SD-Card contains a wrong image file, the SD-Card was formatted or the SD-Card is defect. Different display messages are possible.</p>

10.2 Service alarm clock – 3.3.1.1

The service alarm clock is set via the Hako diagnostic system.

11 Battery charger

11.1 Operating manual



Operating Instructions

page: 1
of: 2

Hako GmbH
D-23843 Bad Oldesloe
Hamburger Straße 209-239
Telephone: (04531) 806-0

Battery Charger
Type: E230 G 36/35 B45-FPO
Hako order no.: 97147524

Date Rev.-No.
19.04.2018 04

Controlled battery charger for lead batteries with liquid and solid electrolyte in SNT technology

controlled backup charging – reverse battery protection – protection against short circuit – constant conservation of charge – low AC-current

General information

The housing of the battery charger is made of enclosed sheet metal steel.

The mains connection is made via a special mains connection cable.

Mains fuse (F1): Micro fuse 5x20 mm. Back-up only through value resembles T 10 AH 250V.

The battery charger is protected against short circuits and equipped with a reverse battery protection.

The operating status is indicated with an external LCD-display.

The battery charger should only be opened by qualified personnel.

The charger is especially designed for cleaning machines of the type Scrubmaster B175R and has to be used only in combination with these machines.

Attention: Non-rechargeable batteries can not be charged with this battery charger.

11 Battery charger

11.1 Operating manual

Initial operation

The battery type used in the machine must be set before commissioning (customer service).

The mains connection (230V AC, 50-60Hz) has to be implemented with a delay-action fuse.

The charger is connected to the mains with the mains plug.

To charge the battery, follow the instructions of the battery manufacturer!

Important note

Before using a new battery for the first time, initial operation charge is always required (please see also battery manual). This is accomplished by doing a regular charging process. Only after the charge cycle is fully completed with the "End of Charge" indication, the machine can be used.

For maintenances-free PzV-batteries an additional 15h compensation charge is recommended.

Sequence of connection

The charger has to be disconnected from the mains supply before connecting/disconnecting the charge plug/cables to the battery.

The battery charger complies with the protection regulations of the low voltage guideline 2014/35/EU and the guideline for electromagnetic compatibility 2014/30/EU.



EN 60 335-1
EN 60 335-2-29
EN 60 335-2-72

11 Battery charger

11.1 Operating manual



Operating Instructions

page: 2
of: 2

Hako GmbH
D-23843 Bad Oldesloe
Hamburger Straße 209-239
Telephone: (04531) 806-0

Functional description and monitoring of charging process

The battery charger begins to charge automatically as soon as the battery is connected, the mains plug is plugged in and the machine has enabled the charging process. The driving-off protection is a potential-free contact preventing the use of the machine during the charging process.

At first the battery connections are checked at the start of battery charging. During charging, the charging states are sequentially run through and shown on the display. After completing the backup charge, the battery is completely charged. Afterwards the device automatically switches to end of charge with a constant conservation of charge.

An uninterrupted charging process is a prerequisite for a properly fully charged battery. Interrupting the charge in the meantime can cause loss of capacity and premature battery failure.

"Battery not connected" is detected immediately when switching on the battery charger during operation and also at the latest 60 seconds after disconnecting the battery.









Please make sure that there is no reverse connection of the battery during this time!

When the battery is connected again, the charger switches on again.

11 Battery charger

11.1 Operating manual

Indication of operating status by the external display

operating status during charging	LCD-display				
					
Main charge $V_{Bat} < 2VpC$	X				
Main charge		X			
Backup charge			X		
End of charge/Conservation of charge				X	
operating status during malfunction*					details
Battery malfunction (battery missing, reverse polarity or defective)				X	$V_{Bat} < 0,2 VpC$
Battery voltage (during start-up too high)				X	$V_{Bat} > 2.4 VpC$ automatic switch on, as soon as $V_{Bat} < 2.4 VpC$
Time malfunction (battery capacity too high, battery deeply discharged or defective)		X			$V_{Bat} < 1.5 VpC$ for longer than 40 minutes; constant current phase (I_1) too long
Temperature malfunction (temperature in the charger too high)			X		charger overheated, charger polluted, ambient temperature too high
System malfunction (other defect)				X	internal device error (case of service)

* If there is a malfunction, the battery frame is flashing once a second.

11 Battery charger

11.1 Programming the charger

The integrated charger is adjusted and parametrised exclusively via the machine control unit. (See Chapter 6.1.4 and 6.1.5)

12. Options

Both factory and field options are available for the Scrubmaster B175 R series. The factory options are only available for new machines ex factory. The field options can be retrofitted in the machines.

The parameters for the options that require a release via the machine's control system are specified in Table 12.1.

All the options are available only with the latest software revision. Some options may require additional hardware, which cannot be fitted to old machines :

- Silence Kit (suction turbine rotating speed reduction - activated by default)
- Optical and acoustical warning signal
- Chemical dosing
- Scrubbing-suction tool
- Front-mounted sweeper attachment
- Working light
- Fleet-Recorder
- Side broom unit (only for the roller brush unit)
- Second suction turbine (default with 108 cm rotating brush unit)
- Flashlight on a pole / on the roof
- Spray tool / spray nozzle
- Blue spot

12. Options

To adjust and check these values, access the programming level as described in Chapter 2.4 and enable the options.

The “silence kit” is the default setting in all machines, but can be deactivated.

The mechanical installation of the field options, if necessary, is described in the supplied instructions for these field options.

The options acoustic and optical warning signal and Blue-Spot can not be activated at the same time. When the option Blue-Spot is activated, the option warning signal automatically is deactivated.

The same restriction applies for the options pre-sweep attachment and the side broom unit.

12. Options

Chapter	Configuration	Content	Description	B175R
1	0		Silence-Kit	
1	0	0	not available	x
1	0	1	available	d
1	1		Warning Signal (Optical and acoustical)	
1	1	0	not available	d
1	1	1	available	x
1	2		Chemical Dosing Agent	
1	2	0	not available	d
1	2	1	available	x
1	3		TOOL	
1	3	0	not available	d
1	3	1	available	x

12. Options

Chapter	Configuration	Content	Description	B175R
1	4		Pre Sweep Unit	
1	4	0	not available	d
1	4	1	available	x
1	6		Working Headlight	
1	6	0	not available	d
1	6	1	available	x
1	7		Fleetrecorder	
1	7	0	not available	d
1	7	1	available	x
1	8		Side Broom (see also parameter F.0.X.)	
1	8	0	not available	d
1	8	1	available	x

12. Options

Chapter	Configuration	Content	Description	B175R
1	9		Second Suction Motor	
1	9	0	not available	d
1	9	1	available	x
1	A		Warning Beacon on Pole	
1	A	0	not available	d
1	A	1	available	x
1	B		TOOL - Spinkle Nozzle (for cleaning of the recovery tank)	
1	B	0	not available	d
1	B	1	available	x
1	C		BlueSpot	
1	C	0	not available	d
1	C	1	available	x
F	0		Elektrical Connetion of the Side Broom Unit	
F	0	0	Connection via external module	x
F	0	1	Connection to machine control unit -A01 Preswep unit and Sidebroom unit can be used together in a machine	d

13. Electrical components

13.1 Machine controller A01

Position of connections and fuses on machine controller A01

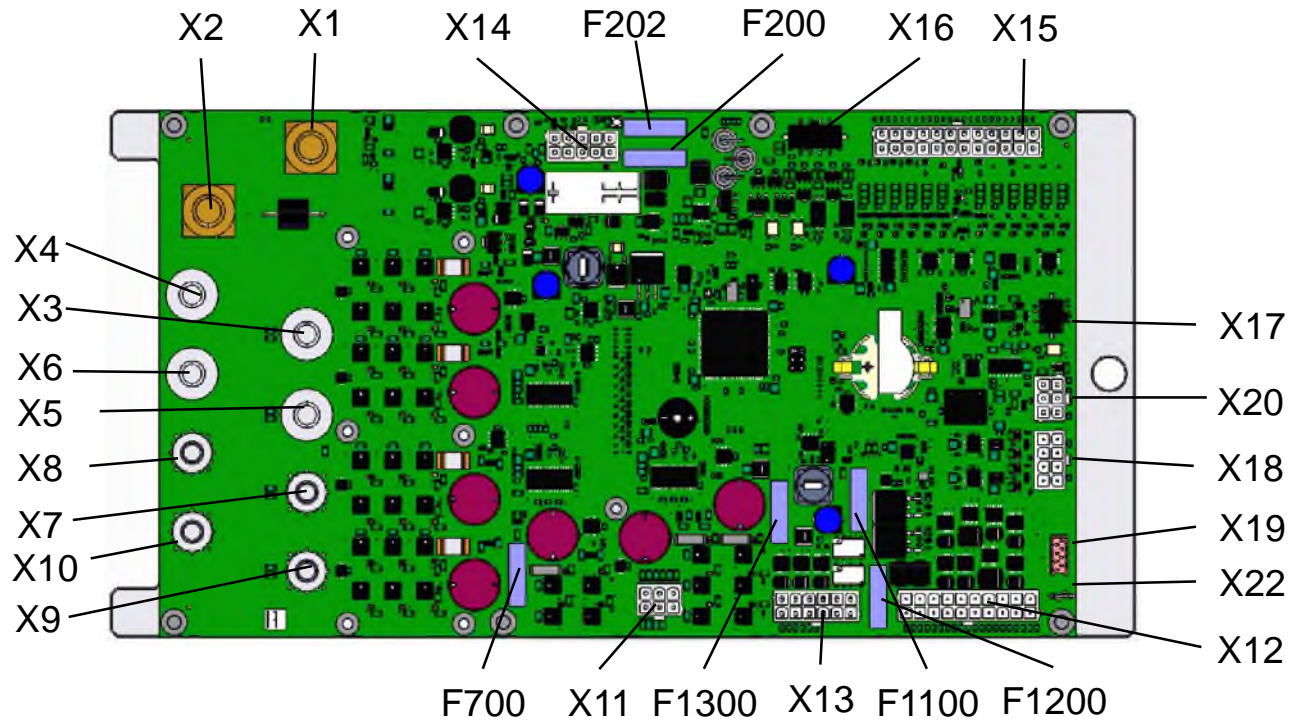

13. Electrical components

13.1 Machine controller A01

Nominal current strengths of the fuses and protected outputs

Fuses A01:	F200 – 3 A/80 V	Control voltage plus
	F202 – 3 A/80 V	Control voltage minus
	F700 – 25 A/80 V	Lifting elements and side brushes – X11.1/4;2/5;3/6
	F1100 – 10 A/80 V	Small load 36 V – X12.3/13;4/14;5/15;6/16;7/17;8/18;9/19;10/20
	F1200 – 10 A/80 V	Water pump – X12.1/11
	F1300 – 10 A/80 V	Small load 24V - X13.1/7;2/8;3/9

13. Electrical components

13.1 Machine controller A01

Connectors on the machine control unit A01

Connectors A01:	X1 / X2	Main Power supply plus and Minus from F02
	X3/4 & X5/6	Power output brush motor 1 & 2 (M03 & M04)
	X7/8 & X9/10	Power output suction motor 1 & 2 (M16 & M17)
	X11 (6-pole)	connector lifting element squeegee and brush aggregat;
	X12 (20-pole)	small load output
	X13 (12-pole)	24V output; X13.1/7 – power supply position recognition
		lifting element brush aggregat;
		X13.3/9 power supply chemical dosing system (24V)
		X13.4/6 enabling Side broom module
		X13.10/11 Relaiscontact enable drive control units

13. Electrical components

13.1 Machine controller A01

Connectors on the machine control unit A01

Connectors A01:	X14 (10-pole)	Input control voltage X14.1/6; (F200 – control voltage plus and F202 – control voltage minus) output Main contactor X14.2 USB- Socket X14.3/9 – 5V / X14.4/8 Terminated communication 5V-supply solution tank filling level sensor X14.5
	X15 (24-pole)	Analogous und digital inputs
	X18 (8-pole)	CAN-Bus connections
	X20 (6-pole)	Serial connector for communication Fleetrecorder
	X22 (1-pole)	VGND

13. Electrical components

13.2 Dash board A02

Position of connectors on Dash board A02

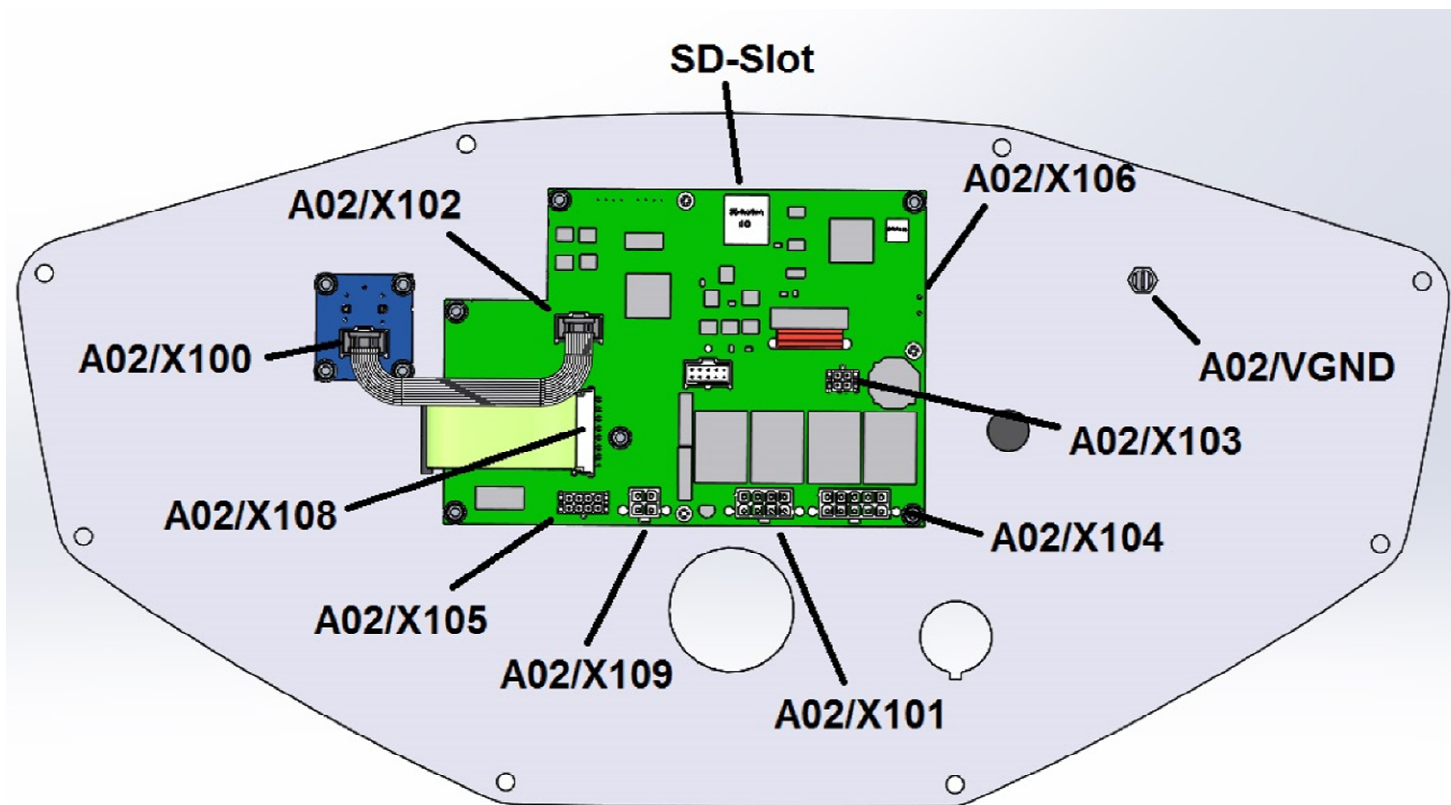

13. Electrical components

13.2 Dash board A02

Description of the connectors on A02

Connectors A02:	X100	Turn-Push-button (DDS)
	X101 (8-pole)	Control voltage
	X102	Connector Turn-Push-Button (DDS)
	X103 (4-pol)	CAN-Bus Connection Battery Charger
	X104 (10-pole)	potential free Relais contacts: horn (X104.5/10), change over working headlight (X104.1) (input) -> Machine (X104.2) / -> pre sweep (X104.3)
	X105 (8-pole)	CAN-Bus connection CAN1H (X105.1) / CAN1L(X105.2) CAN-GND (X105.5)
	X106 (1-pole)	VGND-connection to A02.VGND and Chassis
	X109 (4-pole)	direction switch Power supply 36V (X109.1), Batt- Drive Control (X109.2); Direction signal forward (X109.3); Direction signal revers (X109.4)

14. Notes